

# LokPilot 5

## Instruction manual

7. Edition, May 2021

From Decoder Firmware 5.3.128

LokPilot 5

LokPilot 5 DCC

LokPilot 5 micro

LokPilot 5 micro DCC

LokPilot 5 L

LokPilot 5 Fx

LokPilot 5 Fx DCC

LokPilot 5 Fx micro

LokPilot 5 Fx micro DCC



<b>1. Declaration of Conformity</b> .....	<b>6</b>
<b>2. WEEE-Declaration</b> .....	<b>6</b>
<b>3. Important Notes – Please read this chapter first...</b>	<b>7</b>
<b>4. How this manual helps you</b> .....	<b>7</b>
<b>5. Introduction - The LokPilot family</b> .....	<b>8</b>
5.1. The members of the LokPilot Family .....	8
5.1.1. LokPilot 5 .....	8
5.1.2. LokPilot 5 DCC .....	8
5.1.3. LokPilot 5 micro .....	8
5.1.4. LokPilot 5 micro DCC .....	9
5.1.5. LokPilot 5 L .....	9
5.1.6. LokPilot 5 Fx, LokPilot 5 Fx micro DCC .....	9
5.1.7. LokPilot 5 Fx micro, LokPilot 5 Fx micro DCC .....	9
5.1.8. Overview of all LokPilot 5 decoders .....	10
5.2. General properties of all Decoders .....	12
5.2.1. Operating Modes .....	12
5.2.2. Motor control .....	12
5.2.3. Analogue Mode .....	12
5.2.4. Functions .....	12
5.2.5. Programming .....	13
5.2.6. Operational Reliability .....	13
5.2.7. Protection .....	13
5.2.8. Future built-in .....	13
<b>6. Installing the Decoder</b> .....	<b>14</b>
6.1. Requirements for Installation .....	14
6.2. Installing the Decoder .....	14
6.3. Locomotives with 8-pin NEM652-Interface .....	14
6.4. Locomotives with 6-pin NEM651-Interface .....	14
6.5. Locomotives with 21MTC Interface .....	14
6.5.1. Märklin® locomotives with 21MTC Interface .....	15
6.5.2. Connecting C-Sine motors („Softdrive-Sinus“) .....	15
6.6. Locomotives with Next18 Interface .....	15
6.7. Locomotives with PluX Interface .....	15

6.8. Locomotives without Interface .....	15
6.8.1. Connection diagram LokPilot / LokPilot micro .....	24
6.8.2. Connection diagram LokPilot 5 L Decoders .....	25
6.8.3. Märklin® wire colours .....	26
6.8.4. Motor- and Track connections .....	26
6.8.4.1. Connecting DC and Coreless Motors .....	26
6.8.4.2. Connecting Universal Motors with HAMO-Conversions .....	26
6.9. Connecting Additional Functions .....	26
6.9.1. Overload Protection of Function Outputs (Blinking) .....	27
6.9.1.1. Suitable Light Bulbs .....	27
6.9.2. Using LEDs .....	27
6.9.3. Types of function outputs .....	27
6.9.3.1. Decoder's function outputs .....	28
6.9.4. Usage of powered outputs .....	28
6.9.5. Usage of Logic level outputs .....	28
6.9.6. Servo outputs .....	28
6.9.6.1. Servo outputs for LokPilot 5 L .....	32
6.9.7. SUSI/Servo/Logic Level outputs .....	32
6.9.8. Suitable Smoke Generators .....	32
6.10. Connecting an external sensor .....	33
6.10.1. HALL Sensor IC .....	33
6.10.2. Reed switch sensor .....	33
6.10.3. Additional sensor inputs .....	33
6.11. Connecting Capacitors .....	33
6.11.1. LokPilot H0, LokPilot micro decoders .....	34
6.11.2. PowerPack for LokPilot and LokPilot micro .....	34
<b>7. Initial Operation</b> .....	<b>36</b>
7.1. Factory Default values .....	36
7.2. Digital Operating Modes .....	36
7.2.1. DCC operation mode .....	36
7.2.1.1. DCC Speed Steps („flashing lights“) .....	36
7.2.1.2. Auto-detection of DCC Speed Steps .....	36
7.2.2. Motorola® mode .....	37
7.2.2.1. 28 Speed Steps .....	37
7.2.2.2. Extended Motorola® Address Range .....	37
7.2.3. Selectrix® mode .....	37

7.2.4. M4 mode.....	37
7.3. Analogue Mode.....	38
7.3.1. Analogue DC operation .....	38
7.3.2. Analogue AC Operation .....	38
<b>8. Decoder Settings (Programming) .....</b>	<b>38</b>
8.1. Adjustable Properties of Decoders .....	38
8.1.1. M4 Configuration Range .....	38
8.1.2. M4, the mfx® compatible protocol by ESU .....	39
8.1.3. Configuration Variables (CVs) .....	39
8.1.3.1. Standardisation in the NMRA.....	39
8.1.3.2. Bits and Bytes .....	40
8.2. Programming with popular Digital Systems.....	40
8.2.1. Programming with DCC Systems .....	40
8.2.2. Programming with the ESU ECoS .....	40
8.2.3. Programming with Märklin® 6021 .....	40
8.2.3.1. Changing to the Programming Mode .....	41
8.2.3.2. Short Mode .....	41
8.2.3.3. Long Mode .....	41
8.2.4. Programming with the Märklin® Mobile Station®.....	41
8.2.5. Programmierung with Märklin® Mobile Station 2.....	42
8.2.6. Programming with the Märklin® Central Station .....	42
8.2.7. Programming with the ESU LokProgrammer .....	42
8.2.8. Programming with the ROCO® Multimaus .....	42
8.2.9. Programming with the ROCO® LokMaus II.....	43
<b>9. Address settings.....</b>	<b>44</b>
9.1. Short Addresses in DCC Mode.....	44
9.2. Long Addresses in DCC Mode .....	44
9.3. Motorola® Address .....	44
9.3.1. Consecutive addresses for more functions .....	44
9.4. Addresses in M4 mode .....	45
9.5. Turning off data protocols not needed.....	45
<b>10. Adapting the Driving Characteristics .....</b>	<b>46</b>
10.1. Acceleration and Deceleration .....	46
10.1.1. Switching Acceleration / Deceleration .....	46
10.1.2. Shunting Mode.....	46

10.2. VMin, Vmax, Speed Curve .....	46
10.2.1. 3-point speed table.....	46
10.3. Changing between Operating Modes .....	47
10.3.1. Changing from Digital to Analogue DC .....	47
10.3.2. Changing from Digital to Analogue AC .....	47
10.3.3. Changing from Analogue to Digital (directional bit).....	47
10.3.4. Changing from Digital to Digital .....	47
10.3.5. Changing modes with Analogue Mode turned off.....	47
10.4. Brake Sectors.....	48
10.4.1. DC Brake Mode .....	48
10.4.2. Märklin® Brake Mode .....	48
10.4.3. Selectrix® Diode Brake Sector.....	48
10.4.4. Lenz® ABC Brake Mode .....	48
10.4.4.1. ABC "slow approach" section .....	48
10.4.4.2. ABC detection threshold.....	48
10.4.4.3. ABC shuttle train control.....	49
10.4.5. ZIMO HLU Brake Mode .....	49
10.4.6. Brake Mode Exit Delay .....	49
10.5. Constant Brake Distance .....	49
10.5.1. Linear Braking Distance .....	49
10.5.2. Constant Linear Braking Distance.....	49
10.5.3. Push-pull trains .....	50
10.5.4. Braking at speed step 0.....	50
10.6. Brake functions.....	50
10.7. Load simulation .....	50
10.8. Settings for Analogue Operation.....	51
10.8.1. DC Analogue Operation .....	51
10.8.2. AC Analogue Operation .....	51
10.9. Parking brake.....	51
10.10. Configure the PowerPack .....	52
<b>11. Motor Control .....</b>	<b>52</b>
11.1. Adjusting Load Compensation .....	52
11.1.1. Parameter for frequently used Motors.....	52
11.1.2. Adjustments for other Motors / „Fine Tuning“ .....	52
11.1.2.1. Parameter „K“ .....	52
11.1.2.2. Parameter „I“ .....	52

11.1.2.3. Reference Voltage.....	53
11.1.2.4. Parameter "K slow".....	54
11.1.2.5. Parameter „K slow Cutoff“.....	54
11.1.2.6. Load control influence at slow speed.....	54
11.1.3. EMF measurement principle.....	54
11.1.3.1. Measurement period.....	54
11.1.3.2. Measurement Gap.....	54
11.1.4. Automatic calibration of the motor.....	55
11.2. Turning off Load Compensation.....	55
11.3. Adapting Load Control Frequency.....	55
11.4. Settings for the C-Sine Motors.....	55
<b>12. Function outputs.....</b>	<b>56</b>
12.1. Available function outputs.....	56
12.2. Allocation of Function Buttons (Function Mapping).....	56
12.2.1. Index CV access.....	56
12.2.2. Function Mapping Chart.....	57
12.2.2.1. Conditions block.....	60
12.2.2.2. Physical function outputs.....	61
12.2.2.3. Logic Functions.....	62
12.2.2.4. Virtual Driving sound.....	63
12.3. Default mapping LokPilot 5.....	63
12.4. Allocation of Function Keys with the LokProgrammer.....	64
12.5. Function output configuration.....	65
12.5.1. Available lighting effects.....	66
12.5.2. How to configure the outputs.....	67
12.5.2.1. Special Functions 1 and 2.....	67
12.5.3. Grade Crossing holding time.....	70
12.5.4. Flash rate.....	70
12.5.5. Automatic Switch-off.....	70
12.5.6. Switch-on and switch-off delay.....	70
12.5.7. Digital Couplers.....	70
12.5.7.1. Coupler Mode.....	70
12.5.7.2. Automatic Coupler Function (Removing/Pushing).....	70
12.5.8. Servo settings.....	71
12.6. Input configuration for wheel sensor LokPilot 5 HO.....	71
12.7. Analogue Settings.....	71
12.8. LGB®-Pulse Sequence Mode.....	71
12.9. Swiss Headlight Mode.....	71
12.10. Virtual Drive Sound Start-up Delay.....	72
<b>13. Random functions.....</b>	<b>72</b>
<b>14. Decoder-Reset.....</b>	<b>73</b>
14.1. With DCC-Systems or 6020/6021.....	73
14.2. With Märklin® systems (not for DCC only Decoders).....	73
14.3. With the ESU LokProgrammer.....	73
<b>15. Special Functions.....</b>	<b>73</b>
15.1. Directional Bit.....	73
<b>16. RailCom®.....</b>	<b>73</b>
16.1. RailComPlus®.....	74
16.1.1. Prerequisites for RailCom® Plus.....	74
<b>17. Firmware Update.....</b>	<b>74</b>
<b>18. Accessories.....</b>	<b>74</b>
18.1. Switching the Centre pick-up.....	74
18.2. HAMO Magnets.....	74
18.3. Wire Harnesses with 8-pole or 6-pole Socket.....	74
18.4. Mounting Adapter boards.....	74
<b>19. Support and Assistance.....</b>	<b>75</b>
<b>20. CV table LokPilot Decoder.....</b>	<b>76</b>
<b>21. Appendix.....</b>	<b>84</b>
21.1. Programming Long Addresses.....	84
21.1.1. Write address.....	84
21.1.2. Read out address.....	84



# Declarations

## 1. Declaration of Conformity

We, ESU electronic solutions ulm GmbH & CO KG, Edisonalle 29, D-89231 Neu-Ulm, declare in sole responsibility that the product

**Product description:** LokPilot 5, LokPilot 5 micro, LokPilot 5 L

**Part number:** 596xx, 598xx, 593xx

complies with all relevant regulations of the Directive for Electromagnet Compatibility (2004/108/EG). The following harmonised standards have been applied:

EN 55014-1:2006 + A1:2009: Electromagnetic Compatibility - requirements for household appliances, electric tools, and similar apparatus - Part 1: Emission - Product

EN 55014-2:1997 + A1:2001 + A2:2008 : Electromagnetic Compatibility - Requirements for household appliances, electric tools, and similar apparatus - Part 2: Immunity - Product family standard.

## 2. WEEE-Declaration

Disposal of obsolete electrical and electronic equipment (as practised in the European Union and other European countries with dedicated collection systems).



This mark on the product, the packaging or the relevant documentation indicates that this product must not be treated like household waste. Instead this product should be disposed of at a suitable collection point for recycling of electrical and electronic appliances. Thus you contribute to avoid negative impact on the environment and people's health that could be caused by inappropriate disposal. Recycling of materials contributes to preserve our natural resources. For more information regarding recycling of this product, please contact your local administration, your waste collection service or the dealer / shop where you purchased this product.

Copyright 1998 - 2021 by ESU electronic solutions ulm GmbH & Co KG. Irrtum, Änderungen die dem technischen Fortschritt dienen, Liefermöglichkeiten und alle sonstigen Rechte vorbehalten. Elektrische und mechanische Maßangaben sowie Abbildungen ohne Gewähr. Jede Haftung für Schäden und Folgeschäden durch nicht bestimmungsgemäßen Gebrauch, Nichtbeachtung dieser Anleitung, eigenmächtige Umbauten u. ä. ist ausgeschlossen. Nicht geeignet für Kinder unter 14 Jahren. Bei unsachgemäßem Gebrauch besteht Verletzungsgefahr.

Märklin® und mfx® sind eingetragene Warenzeichen der Firma Gebr. Märklin® und Cie. GmbH, Göppingen. RailCom® ist ein eingetragenes Warenzeichen der Firma Lenz® Elektronik GmbH, Gießen.

Alle anderen Warenzeichen sind Eigentum ihrer jeweiligen Rechteinhaber.

ESU electronic solutions ulm GmbH & Co. KG entwickelt entsprechend seiner Politik die Produkte ständig weiter. ESU behält sich deshalb das Recht vor, ohne vorherige Ankündigung an jedem der in der Dokumentation beschriebenen Produkte Änderungen und Verbesserungen vorzunehmen.

Vervielfältigungen und Reproduktionen dieser Dokumentation in jeglicher Form bedürfen der vorherigen schriftlichen Genehmigung durch ESU.

# Important Notes

## 3. Important Notes – Please read this chapter first



We congratulate you to your purchase of an ESU LokPilot Decoder. This manual will guide you step by step through the features of your LokPilot Decoder. Please read this manual carefully. Although the LokPilot has been designed as a robust device an incorrect connection may lead to faults or even to the destruction of the device. Avoid any “costly” experiments.

- The LokPilot is exclusively intended for use with model train layouts only. It may only be operated with the components listed here. Any other use is not permitted.
- Any wiring has to be carried out while power is disconnected. Please make sure that no voltage reaches the locomotive while converting it, above all not accidentally.
- Avoid mechanical force or pressure on the Decoder.
- Do not remove the heat shrink sleeve on the Decoder.
- Make sure that neither the LokPilot Decoder nor any blank wire ends may come into contact with the engine chassis (risk of short circuit). Cover any blank ends of unused wires.
- Never solder on the circuit board, extend cables if necessary.
- Never wrap the Decoder in insulation tape, since this may cause overheating.
- Adhere to the wiring principles as outlined in this manual for wiring any external components. Other circuitry may cause damage to the LokPilot.
- Make sure that no wires are squeezed or cut by the model's transmission parts when reassembling the engine.
- Any power supply must be protected by a fuse or circuit breaker to avoid any potential hazards such as burning cables in case of a short circuit. Only use transformers specifically designed for model trains that bear the VDE/EN marks.
- Never operate the LokPilot unattended. The LokPilot is not a (children's) toy.
- Do not expose to wet and humid conditions.

## 4. How this manual helps you

This manual is divided into several chapters that show you step-by-step how to install a LokPilot Decoder.

Chapter 5 provides an overview over the characteristics of each type of LokPilot Decoder.

Chapter 6 describes installation of the Decoder in detail. Please make yourself familiar with the type of motor and the type of interface installed in your locomotive prior to working through chapters 6.2. to 6.12.

You can operate LokPilot Decoders with most commercially available control systems for model trains.

Chapter 7 provides an overview which digital and analogue systems can drive LokPilot Decoders and which special issues to consider.



You will find the factory default settings for the function buttons in chapter 7.1.

You may adjust the default settings of your LokPilot Decoder as desired.

Chapters 8 to 16 explain which parameters are adjustable and how to do it.



We recommend, that you at least read chapters 8 and 9 regarding address settings as well as chapter 11 concerning motor control in order to be able to adapt your LokPilot Decoder optimally to your model locomotive.

A list of all technical data in chapter 5.1.7 and a list of all supported CVs will assist you in case of questions.



If not stated otherwise all information refers to all types of the LokPilot family. Should one particular Decoder not support a specific function, then this is clearly mentioned.

# Introduction - The LokPilot Family

## 5. Introduction - The LokPilot family

### 5.1. The members of the LokPilot Family

LokPilot decoders have been used by thousands of satisfied customers worldwide since their release in 2001 and have earned an excellent reputation: their high reliability in tough system use, the diverse application options thanks to the multi-protocol feature, the unmatched flexible function key mapping and the careful production in our ISO 9000 certified plant in Pilsen / Czech Republic are just some of the reasons that speak for a real LokPilot decoder.

This success story continues with the LokPilot 5. Completely re-developed with a modern 32 bit processor as the „heart“, digital decoders are a bit more „intelligent“ than before.

LokPilot 5 decoders have a further improved engine load control with a clock frequency of up to 50 kHz and noise-optimized engine control, so that coreless or gauge 1 engines will also drive silently in the future with excellent low-speed properties.

LokPilot 5 decoders have numerous outputs for controlling light and additional functions and can control RC servos or SUSI modules if required.

LokPilot 5 decoders are always available as pure DCC or multi-protocol versions.

In addition, many LokPilot 5 decoders can be operated on analog DC and AC systems. The desired operating mode is recognized automatically.

Depending on the command station, up to 32 functions are possible, which can be assigned any number of special functions using the uniquely flexible ESU function mapping. Three new, individually adjustable brake controllers bring additional fun as well as the new random functions, with the help of which lighting effects can also be controlled at random.

Future standards are also no problem: The decoder can be updated at any time using flash technology. The proven LokProgrammer is used for this.

In order to meet different sizes and power requirements of the ve-

hicles, LokPilot 5 decoders are offered in different versions, which we would like to introduce to you first.

#### 5.1.1. LokPilot 5

The LokPilot 5 decoder is intended for use in H0- and 0-gauge locomotives. With its compact dimensions of 21.4mm x 15.5mm it should fit into just about any model.

LokPilot 5 decoders are true quad protocol decoders and support DCC with RailComPlus, Motorola®, Selectrix® as well as the mfx® compatible M4 protocol. In addition they may be operated on analogue DC and AC layouts. Subject to the type of interface up to 14 function outputs are available. Optionally an external PowerPack may be connected as well. Due to its comprehensive lighting and auxiliary functions and its motor power output of 1.5A it is the perfect all-round decoder for your locomotives.

LokPilot 5 decoders are offered with all commonly available interfaces.

#### 5.1.2. LokPilot 5 DCC

The LokPilot 5 DCC decoder is the “twin” of the LokPilot 5. The two share almost all characteristics, however, the LokPilot 5 DCC is a pure DCC decoder and cannot be used on analogue AC systems. This lack of flexibility comes with a lower price.

#### 5.1.3. LokPilot 5 micro

The LokPilot 5 micro is the smallest digital decoder by ESU to date. Thanks to the use of sub-miniature components, 8-layer printed circuit boards and the latest production engineering with its dimensions of 8.0mm x 7.0mm and a thickness of only 2.4mm (2.9mm at the capacitor) it is so small that it fits even into very small Z-, N- or TT-gauge models.

Nevertheless, functionality and robustness have not been compromised compared to the larger decoder types. LokPilot 5 micro decoders are multi-protocol decoders and support DCC with RailComPlus, Motorola® and Selectrix®.

They can also be operated on analogue DC layouts. With at least 4 amplified function outputs and two logic level (servo) outputs you



# Introduction - The LokPilot Family

are now in a position to equip even smaller vehicles with typical lighting functions. An external PowerPack may also be connected. The motor output rated at 0.75A is suitable for almost all applications where space is at a premium.

The LokPilot 5 micro decoder is offered with all commonly available interfaces. The types with Next18 or PluX16 interface are slightly larger (13.0mm x 9.2mm) but they also support the mfx® compatible M4 protocol.

## 5.1.4. LokPilot 5 micro DCC

The LokPilot 5 micro DCC is the “twin” of the LokPilot 5 micro. As a pure DCC decoder it does not support any other digital protocols and therefore is available at a lower price.

## 5.1.5. LokPilot 5 L

With its dimensions of only 51mm x 25.5mm the LokPilot 5 L is not only suitable for 0-gauge models but also for smaller H0-gauge vehicles as well as for all other G- or I-gauge models.

The LokPilot 5 L features a 3A motor output and up to 17 function outputs as well as the option to connect two RC servos. Due to the integral PowerPack, stalling on dirty tracks is something of the past. The LokPilot 5 L is mechanically compatible with the LokSound 5 L and has the same connection pins.

This decoder is always equipped with pin headers and is delivered ex works with an adapter board that has solder termination points.

## 5.1.6. LokPilot 5 Fx, LokPilot 5 Fx micro DCC

The LokPilot 5 Fx and its „twin“ LokPilot 5 Fx DCC is a compact function decoder with a base area of 16.5mm x 15.5mm. It comes in all vehicles of nominal sizes H0 to 0 are used that have no engine output, but still Light effects should be able to switch.

They are suitable for all N- and H0-gauge vehicles without the need for a motor output, but should still be able to switch various lighting effects.

With 10 amplified function outputs and two logic levels (servo) you may now equip smaller models with predotypical lighting functions. You may connect a PowerPack as an option.

LokPilot 5 Fx and LokPilot 5 Fx DCC decoders are equipped with an 8-pin interface, as 21MTC (AUX3, AUX4 switchable logic level or reinforced) or PluX22 version.

## 5.1.7. LokPilot 5 Fx micro, LokPilot 5 Fx micro DCC

The LokPilot 5 Fx micro and its “twin” LokPilot 5 Fx micro DCC are extremely small function decoders measuring 8.0mm x 7.0mm and 2.4mm high (2.9mm at the capacitor).

They are suitable for all N- and H0-gauge vehicles without the need for a motor output, but should still be able to switch various lighting effects.

LokPilot 5 Fx micro decoders are multi protocol decoders and support DCC with RailComPlus, Motorola® and Selectrix®.

In addition they can be operated on analogue DC layouts. With 6 amplified functions outputs and two logic level (servo) outputs you may now equip smaller models with predotypical lighting functions. You may connect a PowerPack as an option.

LokPilot 5 Fx micro decoders are always supplied with an 8-pin interface.



# Overview of all LokPilot 5 decoders

## 5.1.8. Overview of all LokPilot 5 decoders

	LokPilot 5	LokPilot 5 DCC	LokPilot 5 micro cable
DCC operation	Ok	Ok	Ok
Motorola® operation	Ok	-	Ok
M4 operation (mfx® compatible)	Ok	-	Ok
Selectrix® operation	Ok	-	Ok
DC analogue operation	Ok	Ok	Ok
AC analogue operation	Ok	-	-
DCC programming	Ok	Ok	Ok
Programming using 6021, Mobile/Central Station®	Ok	-	Ok
M4 configuration on main and automatic detect	Ok	-	-
RailCom® and RailComPlus®	Ok	Ok	Ok
ABC-, Selectrix®, Märklin®, HLU brake sections	Ok	Ok	Ok
ABC shuttle train	Ok	Ok	Ok
Continuous motor current	1,5A	1,5A	0,75A
Integrated PowerPack	optional	optional	optional
Resilience of the function outputs (Power)	250mA	250mA	180mA
Total load capacity decoder (permanent / short-term)	2,0A (3,0A)	2,0A (3,0A)	0,75A (1,0A)
Number of amplified function outputs	10	10	4
Number of logic level outputs (with SUSI-Pins)	4	4	2
Number of servo outputs (instead of SUSI)	2	2	2
Number of servo outputs (dedicated)	-	-	-
Dimensions in millimeters	21.4 x 15.5 x 4.5	21.4 x 15.5 x 4.5	8.0 x 7.0 x 2.4 (2.9 capacitor)
8-Pin Wiring harness NEM652	59610	59620	59810
6-Pin Wiring harness NEM651	59816	59826	59816
6-Pin Direct connection			59817
6-Pin Direct connection angled 90 degrees			59837
PluX16			
PluX22	59612	59622	
Next18			
21MTC NEM660 (AUX3, AUX4 Logic level at the interface)	59619	59629	
21MTC „MKL“ (AUX3, AUX4 powered at the interface)	59649	59659	
Pin headers with adapter			

LokPilot 5 micro Next18/PluX16	LokPilot 5 micro DCC cable	LokPilot 5 micro DCC Next18/PluX16	LokPilot 5 L	LokPilot 5 Fx 5 micro (DCC)
Ok	Ok	Ok	Ok	Ok
Ok	-	-	Ok	(Ok)
Ok	-	-	Ok	-
Ok	-	-	Ok	(Ok)
Ok	Ok	Ok	Ok	-
Ok	-	-	Ok	Ok
Ok	Ok	Ok	Ok	(Ok)
Ok	-	-	Ok	-
Ok	-	-	Ok	Ok
Ok	Ok	Ok	Ok	Ok
Ok	Ok	Ok	Ok	Ok
Ok	Ok	Ok	Ok	Ok
0,75A	0,75A	0,75A	3,0A	-
optional	optional	optional	Yes, 2x 1F/2.7V	Yes, 2x 5F/2.7V
180mA	180mA	180mA	500mA	180mA
0,75A (1,0A)	0,75A (1,0A)	0,75A (1,0A)	3,0A (4,0A)	1,5A(2,0A)
6	4	6	11	6
2	2	2	5	2
2	2	2	2	2
-	-	-	2	-
13,0 x 9,2 x 2,9	8,0 x 7,0 x 2,4 (2.9 capacitor)	13,0 x 9,2 x 2,9	25,4 x 51,8 x 14,0	8,0 x 7,0 x 2,4 (2.9 capacitor)
	59820			59110, 59120 (DCC)
	59826			
	59827			
	59857			
59814		59824		
59818		59828		
			59315	

## 5.2. General properties of all Decoders

### 5.2.1. Operating Modes

All LokPilot 5 decoders (Except the “DCC” versions) are true multi-protocol decoders with automatic detection of the operating mode „on-the-fly.“ The decoder analyses the track signal and filters out the part that is reserved for it. Changing from digital to analogue and back represents no problem whatsoever. This is important in case your e.g. fiddle yard still works in analogue mode. Furthermore, all LokPilot decoders support the relevant brake modes such as ROCO®, Lenz® or Märklin® and stop as intended.

Especially the ABC brake sections are suitable for a simple stop in front of the signal. LokPilot decoders achieve the maximum compatibility with the operating system in order to enable you to simulate even some unusual operational requirements.

The LokPilot 5 supports and automatically detects the DCC protocol with 14, 28, or 128 speed steps. Of course, operation with the long 4-digit addresses is possible as well.

Contrary to the original Märklin®-decoders, LokPilot 5 decoders support up to 255 addresses and 28 speed steps in Motorola® mode. With the appropriate command station such as the ESU ECoS, you can expand the system limits of the Motorola® system considerably.

Furthermore, all LokPilot 5 decoders support RailComPlus®. A RailComPlus®-compatible command station immediately recognises a LokPilot 5 decoder fully automatically. The decoder will transfer all of its important data to the command station. Finally, you will never have to look for a loco address once again or carry out any function mapping!

All LokPilot 5 decoders also support operation with M4 and register automatically with Märklin® mfx® central units.

### 5.2.2. Motor control

The most important function of digital decoders is motor control. All LokPilot 5 decoders are designed for universal use and therefore can control all commonly available DC motors, regardless if they are by ROCO®, Fleischmann®, Brawa®, Mehano®, Bemo®, LGB®, Hübner®, Märklin® or others. Coreless motors (such as Faulhaber® or Maxon®) also work fine with LokPilot.

You may continue to use any universal motors provided you replace the stator coils with a permanent magnet. You will find more info on this topic in chapter 6.8.4.2.

6th-generation load compensation works with an adjustable PWM frequency between 10 to 50 kHz and assures extremely silent operation, particularly with coreless motors. Due to 12-bit technology, your locomotives will crawl at a snail's pace if so desired. Load compensation is easily adjustable to various motor and gear combinations (compare with chapter 11).

The minimum and maximum speed of the LokPilot 5 is adjustable by setting two points which can be optionally adjusted by a speed table with 28 entries. Due to unique load compensation by ESU, there are no visible jerks between speed steps – even in 14-speed-step-mode.

### 5.2.3. Analogue Mode

Quite a few LokPilot decoders replace analogue directional relays. Therefore, you can not only set the starting speed and the maximum speed as well as pre-select which functions should be active in analogue mode: even load compensation works in analogue mode!

### 5.2.4. Functions

Standard features for LokPilot 5 decoders include the following features: acceleration and brake times can be separately adjusted and switched. The brightness of all function outputs can be separately set and allocated to the desired function buttons (function mapping).

There is a wide range of options: dimmer, flickering firebox, gyrolight and mars-light, flash and double flash, blinker and alterna-

# General properties of all Decoders

te blinker as well as switch functions with timers (e.g.: for Telex) and a special coupler function for remote controlled couplers by Krois® and ROCO® including the automatic pushing and pulling. Each LokPilot 5 decoder can control at least 2, LokPilot 5 L decoders up to 4 RC servos directly.

The unique and once more improved ESU function mapping enables you to allocate every function to the function buttons F0 to F31; even multiple allocations are possible. You will find more info on this in chapter 12.

## 5.2.5. Programming

Where intended, LokPilot decoders support all programming modes including POM (Programming-On-the-Main). You can use any NMRA-DCC compatible command station for this purpose. Even with the Märklin® central units 6020®, 6021®, Mobile Station® and Central Station® all settings are adjusted electronically. Most LokPilot 5 decoders support a simple-to-use programming procedure.

Owners of the ESU ECoS enjoy an even more comfortable method of programming: you can read all possible settings in plain text on the large display and easily adjust them – even during operation!

LokPilot 5 decoders will be automatically detected and read by all Märklin® mfx® central units and can be graphically programmed with them (with the exception that the function mapping can not be changed under mfx®).

## 5.2.6. Operational Reliability

LokPilot 5 decoders feature high capacity buffer capacitors and an advanced energy management to ensure reliable operation without “blackout” even on critical track sections. For locomotives with less perfect power pickup, you may consider connecting an additional, external Powerpack Keep-alive module. For LokPilot 5 L the PowerPack module is installed ex factory already.

## 5.2.7. Protection

All function outputs as well as the motor output have protection against overload and short circuit. We want you to enjoy your LokPilot decoders for a long time.

## 5.2.8. Future built-in

All LokPilot 5 decoders are suitable for firmware updates due to the flash memory. You may add new software functions at a later stage.

# Installing the Decoder

## 6. Installing the Decoder

### 6.1. Requirements for Installation

The locomotive must be in perfect operating condition prior to the conversion: Only a locomotive with faultless mechanical properties and smooth running characteristics in analogue mode is worth converting to digital. Check and replace all wear and tear parts such as motor brushes, wheel contacts, light bulbs etc., if necessary.



Please take note of the remarks in chapter 3 in order to prevent possible damage of the decoder during installation!

### 6.2. Installing the Decoder

The components on the decoder must under no circumstances touch any metal parts of the locomotive since this could lead to short circuits and damage or even destruction of the decoder. Therefore, all LokPilot decoders (with the exception of the ones with the 21MTC, PluX or Next18 interface) come with a preductive shrink sleeve.



Never wrap the decoder in insulating tape. If there is no ventilation around the decoder, it may lead to a heat build-up and ultimately to the destruction of the decoder. Rather apply the insulating tape to the metal parts of the locomotive.

Mount the decoder at a suitable location. In most model locomotives, there is a dedicated space for the decoder. To hold the decoder in place use double sided adhesive tape or some (just a little) hot glue.

### 6.3. Locomotives with 8-pin NEM652-Interface

Some LokPilot 5 decoders are supplied with an 8-pin interface as per NEM 652 (refer to Fig 1). Installation in locomotives with this interface is particularly easy:

- Remove the locomotive body. Please observe the instructions in the manual of your locomotive!
- Remove the dummy plug from the socket and keep it in a suitable place for later use.
- Insert the plug of the decoder in such a way that pin 1 of the plug (this is the side with the red / orange wires) sits next to the corner of the socket that is usually marked with \*, +, • or 1. Please make sure that the pins are straight when inserting the plug.



Do not rely on the assumption that the wires of the harness have to face in a certain direction: the only reliable reference is the marking of pin 1.

### 6.4. Locomotives with 6-pin NEM651-Interface

Some LokPilot 5 decoders have a 6-pin NEM 651 plug (as per Fig. 2). Installation in locomotives with this interface is particularly easy:

- Remove the locomotive body.
- Remove the dummy plug from the socket and keep it in a suitable place for later use.
- Insert the plug of the decoder in such a way that pin 1 of the plug (this is the side with the red / orange wires) sits next to the corner of the socket that is usually marked with \*, +, • or 1. Please make sure that the pins are straight when inserting the plug.

### 6.5. Locomotives with 21MTC Interface

Some LokPilot decoders are available with a variant of the 21MTC interface as per Fig. 3. Installation in locomotives with this interface is particularly easy since the plug-socket connector facilitates the mechanical fixing as well.

- Remove the locomotive body. Please observe the instructions in the manual of your locomotive!

# Installing the Decoder

- Remove the dummy plug from the socket and keep it in a suitable place for later use.
- Search for the missing pin in the plug on the circuit board of the locomotive. The missing pin serves as the marker. Memorise its location.
- You can insert the decoder in two ways: either the pins are put through the decoder; the socket of the decoder remains visible after installation (mounting on top) or the decoder is inserted in such a way that the pins go straight into the socket. Once the decoder sits in the socket, the socket is hidden from view. This method is common for Brawa® locomotives.
- Which of the two mounting positions is the correct one depends solely on the locomotive. The position of the marker-pin is the crucial indicator.
- Plug the decoder into the socket in such a way that the locomotive interface corresponds with the decoder.
- Do not apply too much pressure when inserting the plug. The decoder must go in without force.
- Check if the decoder sits correctly.

## 6.5.1. Märklin® locomotives with 21MTC Interface

Many new Märklin® locomotives, but also some British locomotives with 21MTC interface do unfortunately not follow the 21-pin interface standards. These locomotives require the function outputs AUX3 and AUX4 to be powered outputs. In these cases, you need to use the LokPilot 5 Decoder "MKL" Edition. On these decoders only, AUX3 and AUX4 are carried out as powered outputs. The installation as such is done as shown in section 6.5.

## 6.5.2. Connecting C-Sine motors („Softdrive-Sinus“)

The LokPilot decoder cannot drive the newer Märklin® models with C-Sine motors (also called „SoftDrive-Sinus“) directly. To facilitate this, a circuit board supplied ex works with the locomotive is required. This circuit board will be controlled by a LokPilot decoder. Märklin® uses the 21MTC interface installed on this circuit board and thus utilises the normal motor commands from the decoder or a SUSI interface for the exchange of information.

The LokPilot 5 with the 21MTC interface is suitable for controlling the C-Sine control electronics provided some parameters are set accordingly. Chapter 11.4. explains the necessary steps.

## 6.6. Locomotives with Next18 Interface

Some LokPilot micro decoders are shipped with an 18-pin Next18 interface.

## 6.7. Locomotives with PluX Interface

Some LokPilot decoders are supplied with a PluX16 or PluX22 plug (refer figure 6). One position on the multi-pin plug of the decoder has no pin (index pin). This position should be marked in the locomotive. Please observe the correct seating of the decoder on the PluX socket!



LokPilot 5 decoder follow the PluX interface as described in the VHDm RCN-122 standard. Therefore, the index pin has no function. Unfortunately, some locomotives require the index pin to be an output pin, because Austria's ZIMO did not follow the standard. These locomotives do not follow the PluX22 standard.

Some ROCO locomotives expect logic level outputs instead of the SUSI Pins 3 and Pin 4. Although this requirement also breaks the standard, LokPilot 5 decoders can be set to provide a logic level output instead of the SUSI-outputs.

## 6.8. Locomotives without Interface

All LokPilot decoders have an interface (plug). There is no „wires-only“ version. Please remove the plug at the end of the harness should this become necessary.

Please do not extend any wires at the decoder end. If necessary use an extension harness .

Figure 9 and figure 10 show the general wiring diagram for LokPilot 5 and LokPilot 5 micro decoders.

# Installing the Decoder

## 59610 LokPilot 5 59620 LokPilot 5 DCC

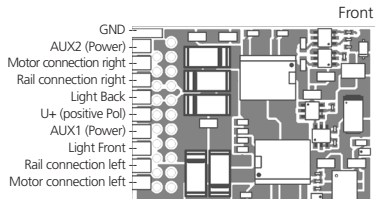

Back

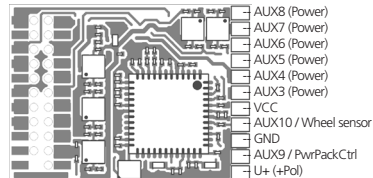

AUX9, AUX10 are logic level inputs/outputs  
AUX9 Default: PwrPackCtrl

## 59810 LokPilot 5 micro 59820 LokPilot 5 micro DCC

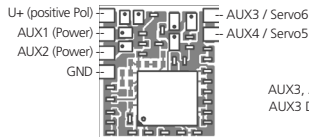
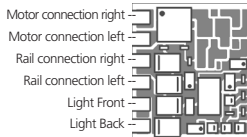

AUX3, AUX4 are logic level outputs  
AUX3 Default: PwrPackCtrl

Pin	Occupancy	Colour
1	Motor connection right	orange
2	Light Back	yellow
3	Ausgang AUX1	green
4	Rail connection left	black
5	Motor connection left	grey
6	Light Front	white
7	U+ (Gemeinsamer Rückleiter)	blue
8	Rail connection right	red

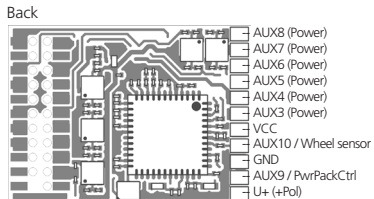
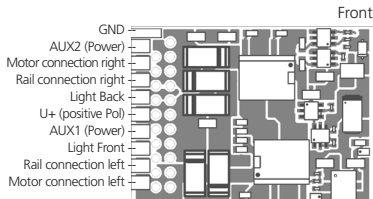

Figure 1: LokPilot 5 & LokPilot 5 micro with 8-pin NEM652 interface



# Installing the Decoder

**59616 LokPilot 5**  
**59626 LokPilot 5 DCC**



AUX9, AUX10 are logic level inputs/outputs  
 AUX9 Default: PwrPackCtrl

**59816 LokPilot 5 micro**  
**59817 LokPilot 5 micro**  
**59837 LokPilot 5 micro**  
**59826 LokPilot 5 micro DCC**  
**59827 LokPilot 5 micro DCC**  
**59857 LokPilot 5 micro DCC**

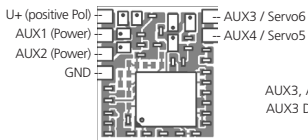
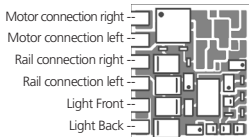

AUX3, AUX4 are logic level outputs  
 AUX3 Default: PwrPackCtrl

Pin	Occupancy	Colour
6	Light Back	yellow
5	Light Front	white
4	Rail connection left	black
3	Rail connection right	red
2	Motor connection left	grey
1	Motor connection right	orange

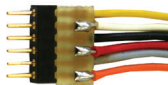

Figure 2: LokPilot 5 & LokPilot 5 micro with 6-pin NEM651 interface

# Installing the Decoder

**59619 LokPilot 5 21MTC**

**59629 LokPilot 5 DCC 21MTC**

**59649 LokPilot 5 21MTC „MKL“ for Märklin Loks from 2008**

**59659 LokPilot 5 DCC 21MTC „MKL“ for Märklin Loks from 2008**

AUX10 / Wheel sensor	1	22	Rail connection right
AUX7 (Logic level)	2	21	Rail connection left
AUX6 (Logic level)	3	20	GND
AUX4 (see below)	4	19	Motor connection right
AUX12 / SUSI Clk / Servo6	5	18	Motor connection left
AUX11 / SUSI Dta / Servo5	6	17	AUX5 (Logic level)
Light back	7	16	U+ (+Pol)
Light front	8	15	AUX1
-	9	14	AUX2
-	10	13	AUX3 (see below)
Indexpin	11	12	VCC

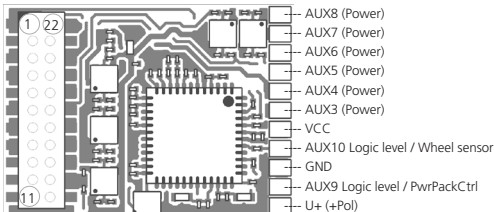

For Decoder 59619, 59629 AUX3, AUX4 at 21MTC interface are Logic level outputs.

**For Decoder 59649, 59659 AUX3, AUX4 at 21MTC interface are reinforced. Not suitable for locomotives with Softdrive-Sinus engine or locomotives built before 2008.**

AUX9, AUX10 are Logic level inputs/outputs  
 AUX11, AUX12 are Logic level outputs  
 AUX9 Default: PwrPackCtrl

## Possible plug directions:



Insert the decoder with  
**Plug up**  
 (e.g. Liliput®, ESU, HAG®, Märklin®)



Insert the decoder with  
**Plug down**  
 (e.g. Brawa®)

Figure 3: LokPilot 5 with 21MTC interface

# Installing the Decoder

## 59818 LokPilot 5 micro Next18 59828 LokPilot 5 micro DCC Next18

Rail connection right	1	18	Rail connection right
Motor connection right	2	17	Light back
AUX1 (Power)	3	16	-
AUX3 / Susi Clk / Servo6	4	15	U+ (+Pol)
GND	5	14	GND
U+ (+Pol)	6	13	AUX4 / Susi Dta / Servo5
-	7	12	AUX2 (Power)
Light front	8	11	Motor connection left
Rail connection left	9	10	Rail connection left

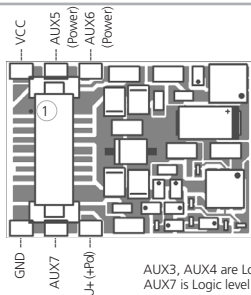

Figure 4: LokPilot 5 micro Next18

## 59814 LokPilot 5 micro PluX16 59824 LokPilot 5 micro DCC PluX16

-	17	18	AUX2 (Power)
-	15	16	AUX1 (Power)
Light back	13	14	Rail connection left
Indexpin	11	12	Rail connection right
U+ (+Pol)	9	10	Motor connection left
Light front	7	8	Motor connection right
GND	5	6	-
AUX3 / Susi Clk / Servo6	3	4	AUX4 / Susi Dta / Servo5

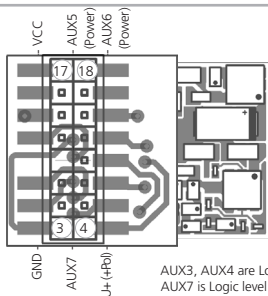
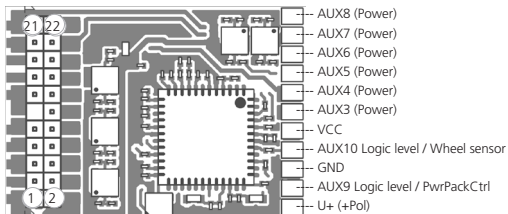

Figure 5: LokPilot 5 micro PluX16

# Installing the Decoder

## 59612 LokPilot 5 PluX22 59622 LokPilot 5 DCC PluX22

AUX6 (Power)	21	22	AUX7 (Power)
AUX4 (Power)	19	20	AUX5 (Power)
-	17	18	AUX2 (Power)
-	15	16	AUX1 (Power)
Back light	13	14	Rail connection left
Indexpin	11	12	Rail connection right
U+ (+Pol)	9	10	Motor connection left
Front Light	7	8	Motor connection right
GND	5	6	Cap Control
AUX12 / Susi Clk / Servo6	3	4	AUX11 / Susi Dta / Servo5
AUX10 / Wheel sensor	1	2	AUX3



AUX9, AUX10 are Logic level inputs/outputs  
AUX11, AUX12 are Logic level outputs  
AUX9 Default: PwrPackCtrl



Figure 6: LokPilot 5 with PluX22 interface

## 59212 LokPilot 5 Fx PluX22 59222 LokPilot 5 Fx DCC PluX22

AUX6 (Power)	21	22	AUX7 (Power)
AUX4 (Power)	19	20	AUX5 (Power)
-	17	18	AUX2 (Power)
-	15	16	AUX1 (Power)
Back light	13	14	Rail connection left
Indexpin	11	12	Rail connection right
U+ (+Pol)	9	10	-
Front light	7	8	-
GND	5	6	Cap Control
AUX12 / Susi Clk / Servo6	3	4	AUX11 / Susi Dta / Servo5
AUX10 / Wheel sensor	1	2	AUX3

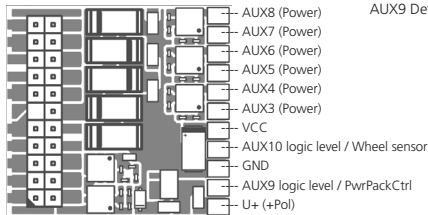

AUX9, AUX10 are logic level inputs/outputs  
AUX11, AUX12 are logic level outputs  
AUX9 Default: PwrPackCtrl

Figure 7: LokPilot 5 Fx & LokPilot 5 Fx DCC with PluX22 interface

## 59210 LokPilot 5 Fx 59220 LokPilot 5 Fx DCC

Front

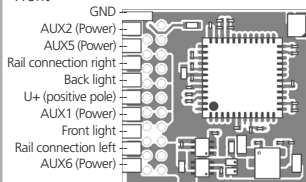

Back

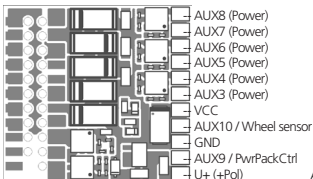

Occupancy	Color
AUX5	orange
Back light	yellow
Ausgang AUX1	green
Rail connection left	black
AUX6	grey
Front light	white
U+ (Return conductor)	blue
Rail connection right	red



AUX9, AUX10 are logic level inputs/outputs

Figure 8: LokPilot 5 Fx & LokPilot 5 Fx DCC with 8-poliger NEM652 interface

## 59219 LokPilot 5 Fx 21MTC 59229 LokPilot 5 Fx DCC 21MTC

AUX10 / Wheel sensor	1	22	Rail connection right
AUX7 (logic level)	2	21	Rail connection left
AUX6 (logic level)	3	20	GND
AUX4 (see right)	4	19	-
AUX12 / SUSI Clk / Servo6	5	18	-
AUX11 / SUSI Dta / Servo5	6	17	AUX5 (logic level)
Back light	7	16	U+ (+Pol)
Front light	8	15	AUX1
-	9	14	AUX2
-	10	13	AUX3 (see right)
Indexpin	11	12	VCC

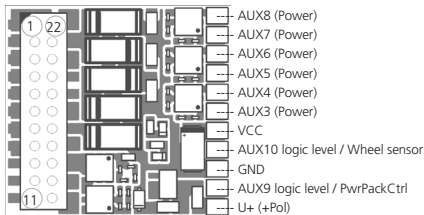

AUX9, AUX10 are logic level inputs/outputs  
AUX11, AUX12 are logic level outputs

AUX3, AUX4 (on the 21MTC interface !!!) can be switched to logic level (NEM660) or power.

Logic level: CV124 Bit 7 = 0  
Power: CV124 Bit 7 = 1

Figure 9: LokPilot 5 Fx & LokPilot 5 Fx DCC with 21MTC interface

# Installing the Decoder

## 59315 LokPilot 5 L

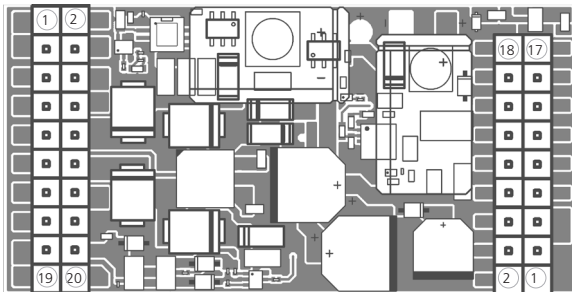

AUX1 (Power)	1	2	Light front
AUX2 (Power)	3	4	Light back
AUX3 (Power)	5	6	Motor connection right
AUX4 (Power)	7	8	Motor connection left
AUX5 (Power)	9	10	Rail connection right
AUX6 (Power)	11	12	Rail connection left
AUX7 (Power)	13	14	U+ (+Pol)
AUX8 (Power)	15	16	-
AUX9 (Power)	17	18	-
-	19	20	-

Motor Enable	18	17	AUX10 / Wheel sensor
Sensor2	16	15	Sensor1
AUX11 / Susi Dta / Servo5	14	13	AUX12 / Susi Clk / Servo6
Servo4	12	11	Servo3
-	10	9	-
-	8	7	-
AUX13 (Logic level)	6	5	+5V (for Servos)
VCC	4	3	GND
-	2	1	-

AUX10 is Logic level inputs/outputs  
 AUX11, AUX12, AUX13 are Logic level outputs

Figure 10: LokPilot 5 L Pinheader - Occupancy

# Installing the Decoder

59110 LokPilot 5 Fx micro  
59120 LokPilot 5 Fx micro DCC

Note: Fx-decoders do not have a motor output!

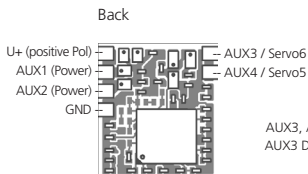
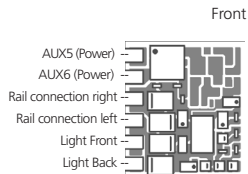

AUX3, AUX4 are Logic level output  
AUX3 Default: PwrPackCtrl

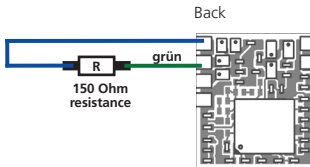

When programming with DCC central units, a resistor with 150 Ohm ( $> = 0.5W$ ) must be connected to the AUX1 output to generate the ACK pulse!

(Not necessary when programming with ESU LokProgrammer)

Pin	Occupancy	Colour
1	AUX5	orange
2	Light Back	yellow
3	output AUX1	green
4	Rail connection left	black
5	AUX6	grey
6	Light Front	white
7	U+ (General Return conductor)	blue
8	Rail connection right	red



Figure 11: LokPilot 5 Fx micro with 8-pin NEM652 interface - Occupancy

# Connection diagram LokPilot

## 6.8.1. Connection diagram LokPilot / LokPilot micro

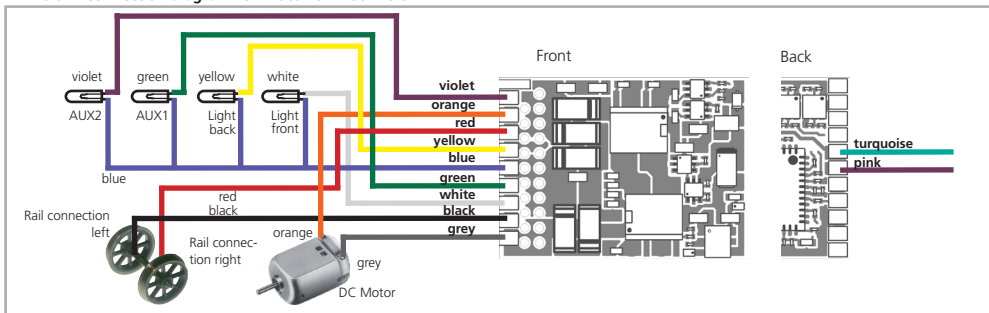

Figure 12: General Connection diagram LokPilot 5 (Example wiring)

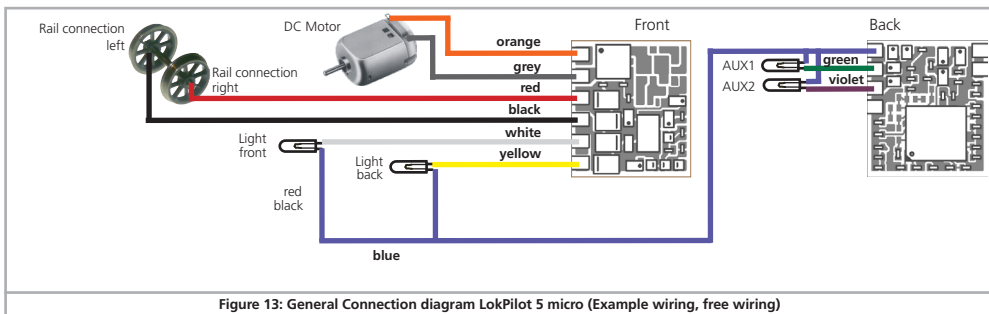

Figure 13: General Connection diagram LokPilot 5 micro (Example wiring, free wiring)



# Connection diagram LokPilot 5 L

## 6.8.2. Connection diagram LokPilot 5 L Decoders

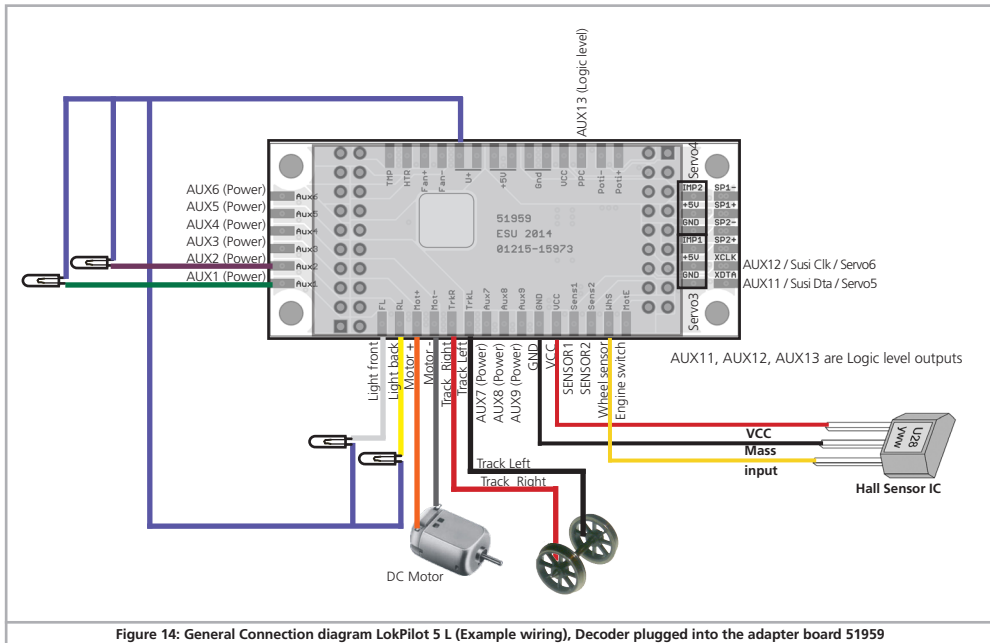

Figure 14: General Connection diagram LokPilot 5 L (Example wiring), Decoder plugged into the adapter board 51959

# Installing the Decoder

## 6.8.3. Märklin® wire colours

Märklin® uses a different colour coding system compared to the DCC colours. Please refer to figure 15 for more information.

Description	Colour Märklin	Colour ESU (NMRA DCC-Norm)
AC: Power pick up show (Center rail)	red	red
DC: Right track connection		
AC: Outside rails	brown	black
DC: Left track connection		
Left motor terminal	blue	grey
Right motor terminal	green	orange
Common (rectified track voltage) (+Pole) for function outputs	orange	blue
Function output Rearlight	yellow	yellow
Function output Headlight	grey	white
Function output AUX1	brown/red	green
Function output AUX2	brown/green	violet
Function output AUX3	brown/yellow	-
Function output AUX4	brown/white	-

Figure 15: Märklin® cable colours different from DCC cable colours

## 6.8.4. Motor- and Track connections

Firstly, please cut all wires installed in the locomotive. Take special care to remove any connections to the chassis (ground): the motor leads must be positively potential-free, in other words they may not have any contact to the chassis or body or the wheels and wheel contacts.

It is particularly easy to overlook such connections in Fleischmann® locomotives.

Make notes of which motor lead connects the motor with the right and the left wheel contact. This avoids mistakes and assures that your locomotive runs in the right direction.



Please check all connections with an Ohmmeter. Search for short circuits, particularly between the motor leads and the wheel contacts.

- Connect the red wire to the right rail pickup or the centre pick up in AC models.
- Connect the black wire to the left rail pickup or the chassis in AC models.
- Connect the orange wire with the motor terminal, which originally lead to the right wheel pick up (centre pick up in AC models).
- The grey wire goes to the terminal, which originally connected to the left rail (chassis for AC models).

### 6.8.4.1. Connecting DC and Coreless Motors

You may use all DC motors commonly used for model trains provided they do not exceed the current limit of the decoder.

In some cases with the 5-pole High Performance Drive by Märklin®, you may find three anti-interference capacitors.

The two capacitors connected directly to the motor leads and the motor housing MUST be removed.

### 6.8.4.2. Connecting Universal Motors with HAMO-Conversions

Do not wire universal motors installed in many older Märklin® locomotives (also known as AC motors) directly to LokPilot decoders. You must modify the motor by first installing permanent magnets – so called HAMO magnets.

You may purchase these magnets from your ESU dealer.

We supply three types of magnets. Please refer to chapter 18.2. for more information regarding motor conversions with permanent magnets.

## 6.9. Connecting Additional Functions

You can wire any kind of load such as light bulbs, LEDs (light emitting diodes), smoke generators or similar devices to the function outputs provided the maximum current draw is less than that of the decoder output.



The permitted maximum current draw per function output is listed in the technical data in section 5.1.8.

# Installing the Decoder



Please make sure that the load does not exceed the permitted maximum current and there are no short circuits. The outputs of the LokPilot have protection but if an external voltage is applied, the outputs may suffer damage or destruction.

## 6.9.1. Overload Protection of Function Outputs (Blinking)

The function outputs of LokPilot decoders have electronic protection against overload and short circuit. The decoder keeps checking the sum of all function output currents. If the current is too high, the decoder will switch off the outputs. After about 1 second, the decoder tries to switch them on again. Should the current still be too high – perhaps due to a short circuit – the same procedure starts again.

When using light bulbs (incandescent lamps) please note the following: they draw a very high „inrush current“ when they are switched on, that becomes lower after a few moments. Therefore, it can happen with 12V bulbs that the headlights „flash“ briefly during switch-on and then extinguish due to the overload protection of the decoder. The lights will be shortly switch on and off again in a one-second cycle. This results from a much too high inrush current of the bulbs; the decoder is not able to distinguish between the bulbs' high inrush current and an overload. Therefore it is important to install the correct bulbs.

### 6.9.1.1. Suitable Light Bulbs

Only install bulbs rated 16V or higher and with a nominal current draw, that does not exceed 50 mA.

Many older models by ROCO® and Fleischmann® have 12V bulbs installed. They draw a high current, become very hot, and may cause damage to the locomotive. Replace them with 16V bulbs.

## 6.9.2. Using LEDs

If you like to use LEDs, then a resistor must be wired in series with the LEDs. It should have a rating between 470 Ohms and 2.2 kOhms. Running the LEDs without this resistor will lead to their immediate destruction! Unlike lightbulbs, LEDs are polarity-sensitive. The minus (cathode) end of the LED is connected to the

function output, the plus (anode) end is connected to the blue (function common) wire.



Please do not forget to switch the respective function output to LED mode. This will ensure a prototypical presentation of all light effects. Please refer to chapter 12.5. for more details.

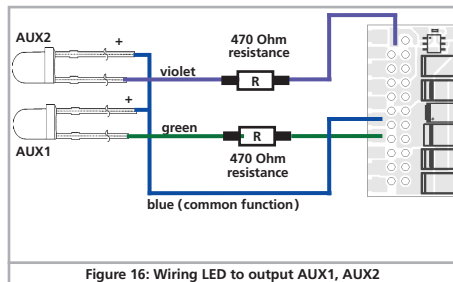

Figure 16: Wiring LED to output AUX1, AUX2

## 6.9.3. Types of function outputs

An important component of every LokPilot decoder are the function outputs. There, all consumers such as lamps, smoke generators or servos are connected. Depending on the version, LokPilot 5 decoders offer different numbers of function outputs. We distinguish two types:

- Powered function outputs: FET transistors are installed directly in the decoder so that consumers can be connected directly to these function outputs.
- Logic level outputs: These outputs provide the control signal for the output only. For use, External power transistors are required. This usually happens on the locomotive printed circuit board; ESU also offers suitable adapter boards.

# Installing the Decoder

## 6.9.3.1. Decoder's function outputs

ESU names the function outputs as „Front Light“, „Rear Light“, as well as AUX1, AUX2, AUX3 ... The table on the next page shows which decoder has which outputs.



Not every output is available on every connector. For some connections, you can either choose between input or output or select the type of output (logic level output, SUSI or servo), depending on the external wiring (locomotive printed circuit board or adapter board).

## 6.9.4. Usage of powered outputs

This procedure depends on the wiring of the lights and auxiliary functions in the locomotive:

- The lamps / function outputs are insulated from the common pole (ground) (i.e.: the locomotive chassis); therefore they are potential free. The functions of the locomotive must be potential-free, in other words there may not be any other connection to the function besides the wires from the decoder. The voltage at these outputs is about 1.5V lower than the track voltage. The blue wire is the „common pole“; the function output itself is the „minus-pole“.



If LEDs are installed (also refer to Fig. 17), then a resistor must be wired in series with the LEDs. It should have a rating of between 470 Ohms and 2.2 kOhms. Running the LEDs without this resistor will lead to their destruction!

- The lamps / function outputs are wired (together) against the chassis of the locomotive (as in many locomotives by Märklin® as well as in most older locomotives by Fleischmann® and ROCO®).

The wiring is simpler but the available voltage is about half. This type of connection is not suitable for multi-protocol operation:

Both M4 and Motorola® packets are asymmetrical. Therefore, the function outputs do not have continuous power. This leads to a rhythmic flicker of the headlights (pulsing) that becomes particularly obvious with LEDs.



Furthermore, the headlights will only work in one direction in analogue DC mode. Whether it will be the forward lights or the backup lights depends on which way you have placed your locomotive on the track.

- Solder the backup lights to the yellow wire, the headlights to the white one.



If your locomotive is wired according to option b), then it is ready for use. Otherwise, you must connect the remaining wires of all bulbs and functions together to the blue wire. This pole may not have any connection to the chassis! It is possible to use both options in the same locomotive.

## 6.9.5. Usage of Logic level outputs

For logic level outputs, it is not possible to connect any external loads directly. External power transistors are required. Usually, these power transistors are already installed to the locomotive printed circuit board (if needed).

For “do it yourself” model railroaders, ESU offers the adapter boards 51957 and 51968 that matches perfectly our decoders.

## 6.9.6. Servo outputs

LokPilot 5 decoders are capable to drive up to 6 servos. All commercially available RC servos with a positive pulse are suitable. We recommend so called Digital Servos because these do not move during power up. Prior to controlling the servos you must set the function outputs to “Servo”. Each servo output can also be used as logic level output alternatively. Please refer to chapter 12.5. for more information.



Please note that LokPilot 5 and LokPilot 5 micro can create the needed control signal for the servo control, but can not provide the needed power supply for the servos (typically 5V). You need to generate the servo power supply by yourself on the adapter board. LokPilot 5 L decoder however have the servo power supply on board already.



# Installing the Decoder

	LokPilot 5	LokPilot 5	LokPilot 5	LokPilot 5
	6- oder 8- pin	21MTC	21MTC „MKL“	PluX22
Light front	Power	Power	Power	Power
Light back	Power	Power	Power	Power
AUX1	Power	Power	Power	Power
AUX2	Power	Power	Power	Power
AUX3	Pad: Power	Pad: Power 21MTC: Logic level	Pad: Power <b>21MTC: Power</b>	Pad: Power PluX22: Power
AUX4	Pad: Power	Pad: Power 21MTC: Logic level	Pad: Power <b>21MTC: Power</b>	Pad: Power PluX22: Power
AUX5	Pad: Power	Pad: Power 21MTC: Logic level	Pad: Power 21MTC: Logic level	Pad: Power PluX22: Power
AUX6	Pad: Power	Pad: Power 21MTC: Logic level	Pad: Power 21MTC: Logic level	Pad: Power PluX22: Power
AUX7	Pad: Power	Pad: Power 21MTC: Logic level	Pad: Power 21MTC: Logic level	Pad: Power PluX22: Power
AUX8	Pad: Power	Pad: Power 21MTC:	Pad: Power 21MTC:	Pad: Power PluX22:
AUX9	Pad: Logic level (PwrPackCtrl)	Pad: Logic level (PwrPackCtrl)	Pad: Logic level (PwrPackCtrl)	Pad: Logic level (PwrPackCtrl)
AUX10		21MTC: Logic level/Wheel sensor	21MTC: Logic level/Wheel sensor	PluX22: Logic level/Wheel sensor
AUX11		21MTC: Logic level/Susi Dta/Servo5	21MTC: Logic level/Susi Dta/Servo5	PluX22: Logic level/Susi Dta/Servo5
AUX12		21MTC: Logic level/Susi Clk/Servo6	21MTC: Logic level/Susi Clk/Servo6	PluX22: Logic level/Susi Clk/Servo6
AUX13				
AUX14				
AUX15				
AUX16				
AUX17				
AUX18				
Input Wheel sensor		21MTC: as alternative to AUX10	21MTC: as alternative to AUX10	PluX22: as alternative to AUX10
Input Sensor 1				
Input Sensor 2				
Input MotorOff				

LokPilot 5 micro	LokPilot 5 micro	LokPilot 5 L
6- oder 8- pin	Next18 / PluX16	Pinheader
Power	Power	Power
Power	Power	Power
Power	Power	Power
Power	Power	Power
Pad: Logic level/Servo6		Power
	Next18: Logic level/Susi Dta/Servo6	
Pad: Logic level/Servo5		Power
	Next18: Logic level/Susi Clk/Servo5	
	Pad: Power	Power
	Pad: Power	Power
		Power
		Power
		Power
		Logic level / Wheel sensor
		Logic level / Susi Dta/ Servo5
		Logic level / Susi Clk / Servo6
		Logic level (PwrPackCtrl)
		Logic level / Servo3
		Logic level / Servo4
		Ok
		Ok
		Ok
		Ok

# Installing the Decoder

## 6.9.6.1. Servo outputs for LokPilot 5 L

LokPilot 5 L decoder offer 4 servo outputs. The servos need to be connected correctly to the adapter board.

Servo3 and Servo4 can be soldered to the adapter board directly as shown in figure 17. For Servo5 and Servo6 please refer to figure 14.

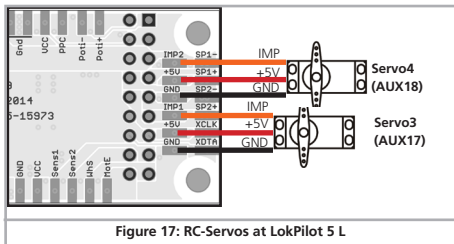

Figure 17: RC-Servos at LokPilot 5 L

## 6.9.7. SUSI/Servo/Logic Level outputs

The SUSI interface lines on each LokPilot 5 decoder can alternatively be configured as servo outputs or logic level outputs. In this way, the number of available outputs can be increased.



Please keep in mind that currently SUSI pins on 21MTC, Next18 or PluX interfaces are not allowed to be used elsewhere according to the standard. You therefore always have to check how these pins are connected to the locomotive printed circuit board (or adapter board).

## 6.9.8. Suitable Smoke Generators

Unfortunately, it is not an easy task to find the right smoke generator for each locomotive. The amount of smoke generated depends on the following factors:

- Track voltage  
The track voltage varies depending on the command station. Therefore, it is possible that a locomotive generates smoke when driven by one digital system but does not generate any smoke with another system. Even 1V variation makes a big difference.
- Type and tolerance of the Seuthe smoke generator and the smoke distillate  
Seuthe smoke generators have considerable production tolerances. Therefore, it is possible that one unit works perfectly well while another does not. Type of distillate and filling level have an influence as well.
- Setting the decoder output  
For correct smoking action you should set the AUX output to „Dimmer“ as well as full „Brightness.“ More info in chapter 12.
- Connecting the smoke generator  
Most smoke generators are wired against the chassis (ground). Therefore the smoke generator only receives current in every second half cycle. How much power gets to the smoke generator depends on your command station and the digital protocol. Generally, Seuthe type 11 is recommended, but it does not get enough power and therefore does not smoke satisfactorily.

There are two options on how to solve this problem:

Solution 1: Using the Seuthe No. 10. This type is intended for analogue operation and draws a relatively high current. Subject to its tolerance levels, it may trigger the overload protection of the decoder. In this case, you must wire a relay (ESU No. 51963) into the circuit or you slightly reduce the „Brightness“ of the output.

Solution 2: Using the Seuthe No. 11. Do not wire it against the chassis (ground) but rather use the blue wire for the second pole („U+“). This prevents the asymmetric track signal from interfering with the smoke generator. It represents the best solution but is sometimes a bit difficult in terms of wiring.



# Installing the Decoder

## 6.10. Connecting an external sensor

If you want to use an external sensor to trigger function, you have a little work to do. LokPilot 5 decoders (unfortunately not the LokPilot 5 micro) support several types of sensors: Hall sensors, reed switches and mechanical wipers. The most accurate result you will get when using a hall sensor IC. After you have installed and connected a wheel sensor, you have to tell the decoder to use it.



Make sure the wheel sensor input is enabled and not setup to be AUX9. For this, Cv 124 Bit 4 needs to be set for LokPilot HO decoders!

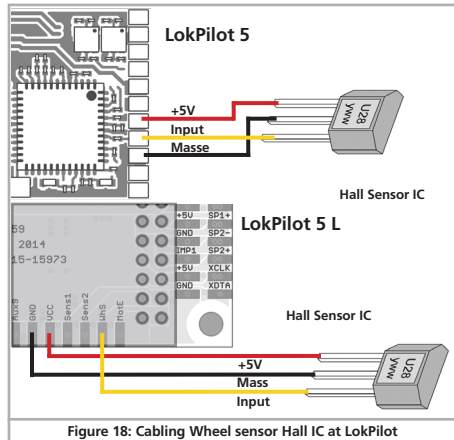

Figure 18: Cabling Wheel sensor Hall IC at LokPilot

### 6.10.1. HALL Sensor IC

A Hall sensor is an electronic circuit that responds to an alternating magnetic field similar to a reed switch. Hall sensors are easier to adjust since the distance between sensor and magnet is not critical. A commonly used hall sensor, that can be purchased via mail order is the US2881 by Melexis.

There are also many compatible devices on the market. The terminals have to be wired to the LokPilot as shown in figure 15.

### 6.10.2. Reed switch sensor

If you have trouble obtaining a hall sensor IC, you may also use a subminiature reed switch. They are connected to the decoder with two pins only.

However, their sensitivity is not as good as hall IC sensors and stronger magnets may be needed in order to trigger these reed switches correctly. Furthermore the position of the reed switches needs to be considered.

### 6.10.3. Additional sensor inputs

For triggering effects the LokPilot 5 L has two additional sensor inputs SENSOR#1 and SENSOR#2 (refer to Fig. 7/11). The inputs are suitable for reed contacts or HALL sensors. The wiring is done as shown above.

## 6.11. Connecting Capacitors

On many older layouts, current pick up of locomotives is not very reliable. Therefore, power interruptions may cause a stop or jerky movement when the locomotive travels over turnouts at low speeds. This can be overcome with buffer capacitors (100 mF / 25V or higher show the desired results). If desired you may connect them to the LokPilot 5 or LokPilot 5 micro.



Soldering wires onto a decoder requires quality soldering equipment and experience. Our warranty does not cover damage caused by inappropriate soldering. Consider carefully if you really need that capacitor.

# Installing the Decoder

## 6.11.1. LokPilot H0, LokPilot micro decoders

You can connect two larger capacitors as per the circuit in the upper half of figure 16.

The capacitor is charged via a resistor (100 Ohms) thus preventing the digital system from interpreting the charging current as short circuit at the time of switch-on. The diode makes sure that the energy of the capacitor is fully available when required.



However, you may not run this locomotive on AC layouts anymore. Risk of destruction!



Disconnect / remove the capacitor prior to programming with the ESU LokProgrammer!

## 6.11.2. PowerPack for LokPilot and LokPilot micro

You can solder a powerful energy buffer to all LokPilot 5 or LokPilot 5 micro decoders. Figure 19 + 20 shows you how to do it. This „PowerPack“ allows your locomotive to keep running for 2 seconds without power.

ESU supplies under the article number 54671 or 54672 suitable PowerPack modules. Please do ONLY use these.

- The PowerPack only operates in digital mode. It automatically turns off on analogue layouts.

It may take up to two minutes to fully charge the capacitor („GoldCap“). Therefore, the time bridged with the energy buffer depends on the current draw of your locomotive and the charge-up time.



The time to be bridged with the PowerPack can be set in CV 113. Output AUX9 or AUX7 needs to be set to „PowerPackControl“. Find more details in chapter 10.10.

# Installing the Decoder

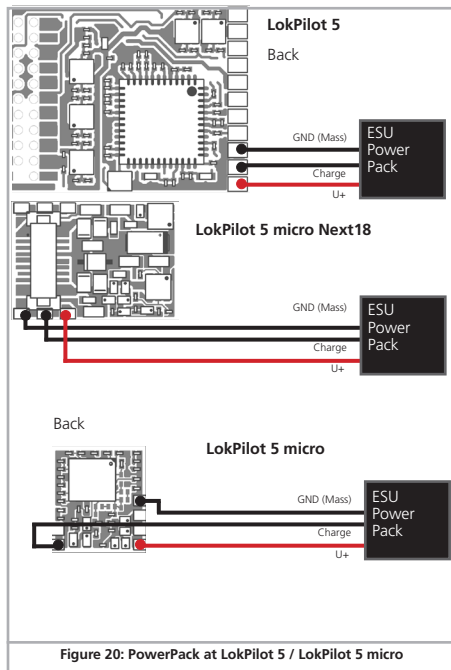
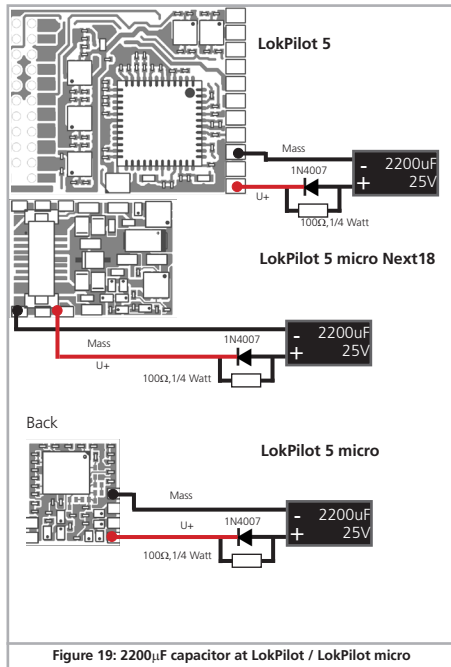

## 7. Initial Operation

### 7.1. Factory Default values

The address is set to 03 with 14 speed steps.

- F0 switches the directional lighting.
- F1 switches output AUX1.
- F2 switches output AUX2.
- F3 switches the switching gear on and off.
- F4 switches the acceleration and braking delay off and on.
- F5 switches output AUX3 (if available).
- F6 switches output AUX4 (if available).
- F7 switches output AUX5 (if available).
- F8 switches output AUX6 (if available).
- F9 switches output AUX7 (if available).
- F10 switches output AUX8 (if available).
- F11 switches output AUX9 (if available).
- F12 switches output AUX10 (if available).
- F13 switches output AUX11 (if available).
- F14 switches output AUX14 (if available).

- Does the locomotive move in both directions?
- Does the indicated direction of travel correspond with the actual one? If not, are the motor leads swapped or is the 8-pin plug inserted the wrong way round.
- Switch on the lights: do they work properly? If you have installed a LokPilot with an 8-pin plug, check if the plug sits in the socket correctly.

### 7.2. Digital Operating Modes

In the following chapters, we describe the operation of the LokPilot with different digital systems.

All LokPilot 5 decoders basically support the digital protocols mentioned in section 5.2.1. Exceptions are the LokPilot 5 DCC, LokPilot 5 micro DCC and LokPilot 5 L DCC decoder, which are intended for the North American market. These support the DCC system only.

### 7.2.1. DCC operation mode

Remove any capacitors that are wired into the track feeders (e.g. ROCO® feeder track). This could impair the functionality of the decoder.



The LokPilot works with any DCC system. Unfortunately, the DCC protocol also brings some difficulties into the game. One of them occurs so often that we deal with it right away.

#### 7.2.1.1. DCC Speed Steps („flashing lights“)

„Lights do not work“ with DCC systems: DCC locomotives run with 14, 28, or 128 speed steps. The decoder offers all of the three options and needs to „know“ with which option the the command station operates the decoder. The command station must be able to operate with this mode and must be set accordingly. If this is not the case, the following problems may occur:

- You cannot switch the lights with F0 at all.
- The lights keep switching on and off dependent on the speed step. On and Off again, and On again, and Off again etc.

In this case, make sure that the speed step settings of decoder and command station are the same.

#### 7.2.1.2. Auto-detection of DCC Speed Steps

LokPilot decoders implement auto-detection to avoid the above problem. We have tested this with the following systems:

- ESU ECoS®
- Bachmann E-Z-Command® Dynamis®
- ROCO® Lokmaus2 and Lokmaus3
- Uhlenbrock® Intellibox
- Lenz® Digital plus V2.3
- ZIMO® MX1
- Märklin® Central Station

When operating with Lenz® digital plus V3.0 the auto-detect feature does not work at 14 speed steps. Select 28 / 128 speed steps instead.

The LokPilot tries to establish the speed step setting every time it receives power (i.e.: after switching on the power on your layout or the track sector where your locomotive is located) and the lights

are switched on. This process requires that you switch on the lights and turn the throttle until the lights light up continuously.

Should you change the speed step setting during operation then you must interrupt the power to the decoder for a short moment in order to activate the auto-detection.

This auto-detect feature can be turned off with bit 4 in CV 49 (also refer to the CV table in chapter 20). Then you have to set the correct speed step with bit 1 in CV 29.

## 7.2.2. Motorola® mode

The LokPilot works with all Märklin® devices and compatible systems that are in the market until now. The functions F1 to F4 can only be activated with the so-called „new Motorola® format.“ In order to activate this you must set the DIP-switch 2 on your 6021 to the upper position („On“).

LokPilot decoders support two special features in Motorola® mode:

### 7.2.2.1. 28 Speed Steps

While the original Motorola® system used by the following central units, namely Märklin® central unit 6021, Delta® and Mobile Station®, only supports 14 speed steps, the LokPilot decoder can also handle the 28-speed step mode. In conjunction with suitable command stations (e.g.: ESU ECoS, in „Motorola® 28“ mode) this leads to smoother control of your locomotives. No changes are required on the decoder.

### 7.2.2.2. Extended Motorola® Address Range

While the original Motorola® format only knows the addresses from 01 to 80, the LokPilot offers the following range of addresses:

LokPilot 5

01 - 255

Chapter 9 explains how to set the address. There it is described how with the aid of the second, third and fourth address (consecutive addresses) more than four functions can be controlled.

## 7.2.3. Selectrix® mode

You may operate the LokPilot with any Selectrix® compatible command station with access to the functions „lights“ and F1.

For programming any parameters, you must use the DCC programming mode. It is not possible to program it with a „pure“ Selectrix® system. Any changes programmed in DCC are also valid for operation with Selectrix® command stations.

As soon as a decoder receives commands in Motorola®, M4 or DCC format (whenever it receives a signal packet with information addressed to it), the Selectrix® receiver switches off automatically. This allows trouble-free mixed operation with Selectrix® / DCC / Motorola®/M4. The Selectrix® receiver turns on again as soon as the decoder detects a power interruption.

## 7.2.4. M4 mode

LokPilot decoder are recognised and embedded into the system automatically by the Märklin® systems devices Central Station®, Central Station® 2/3 and Mobile Station® immediately after placing the locomotive onto the track. This process runs automatically and does not require any specific decoder settings.

As soon as the decoder receives a valid mfx® data packet (whenever the decoder recognizes that it is run by an mfx® capable central unit) it will ignore Motorola®, Selectrix® as well as DCC data packets.

Only after interrupting power to the decoder briefly or if it does not receive any mfx® data packets for about 4 seconds will it accept other data packets again. The decoder prioritises its response to incoming data packages:

- Top priority is assigned to DCC with RailComPlus®. Therefore the decoder will always register with RailComPlus and DCC to an ESU ECoS command station, even when M4 is active.
- If RailComPlus® is not available the second priority is M4. The decoder will register with M4 to Märklin Central Station® command stations.
- „Standard“ DCC is at the same level as Motorola®.
- Selectrix® has the lowest priority.

 Data protocols not required can be turned off. How this is done you find out in chapter 9.5.

## 7.3. Analogue Mode

All LokPilot decoders are set ex factory to operate in analogue mode as well. Please take note of the remarks in chapter 10.3. if the decoder should move repeatedly from analogue into digital sectors and back.

### 7.3.1. Analogue DC operation

LokPilot decoders work on conventional DC layouts. From the factory, load compensation is active. This provides smooth control of your locomotives even at low speeds (in DC mode as well). Since load compensation requires about 3 – 4 Volts as „base voltage“ you must turn the throttle further than normal (=locomotives without decoder) before the locomotive starts moving.

### 7.3.2. Analogue AC Operation

Where intended, LokPilot decoders support operation with AC transformers. Therefore, the LokPilot decoder can simply replace the old directional relay. Load compensation is active (similar to DC mode) and provides smooth control and slow-speed-performance you have never seen before. The LokPilot recognised the pulse for changing direction as usual. Just wait until the locomotive has stopped prior to changing direction.

 Never issue the „Change of Direction“ command to a moving locomotive! This could lead to damaged gears!

 We cannot recommend the use of the old (blue) Märklin® transformers that where originally designed for 220 Volt. Depending on their age and their tolerance range, the pulse for changing direction could be too high in case of increased mains voltage and therefore destroy the LokPilot decoder.

Do yourself and your locomotives a favour and purchase a suitable Märklin® transformer No. 6647 – your locomotives and decoders will thank you with longer product life!

## 8. Decoder Settings (Programming)

Chapter 8 covers setting various parameters of the LokPilot decoder. Should you not be familiar with the handling of CVs please take the time to read these occasionally quite complex instructions.

After an introduction into the world of parameters in chapter 8.1, we explain in the following section 8.2 how to change various parameters in DCC mode and with Märklin® central units.

The chapters 9 to 16 explain which parameters have what kind of influence on the behaviour of the LokPilot decoder.

### 8.1. Adjustable Properties of Decoders

The hardware determines some features such as the number of function outputs as well as the maximum permitted current of the motor output and therefore they are not programmable. Nevertheless, there are plenty of possibilities to influence the behaviour of the LokPilot decoder by adjusting software-governed properties.

There is at least one memory space within the decoder reserved for each adjustable parameter where numbers or letters can be stored.

You could visualise the storage spaces as index cards in a large file box. In order to enable you to find the right card again, they all have numbers and / or names outlining the properties of this particular card such as „locomotive address“ or „maximum speed.“

Then imagine that you can write information onto these cards. Adjusting the settings means nothing else but erasing one entry and replacing it with another. Moreover, you could do that at any time. However, you cannot write onto every card: some bits of information like the manufacturer's code are firmly encoded.

Thus, you can determine the content of the storage spaces in the decoder even during operation and of course, the decoder will follow the instructions. Via the procedure known as „Programming,“ you can enter the desired data into the storage spaces.

#### 8.1.1. M4 Configuration Range

The NMRA CV concept as described above has some disadvantages: On the one hand dealing with „collection CVs“ such as CV

29 with its binary format is complicated while on the other hand you can only enter one value (!). How could one possibly store locomotive names with this method?

Furthermore, it is not possible for the command station to find out, which CVs a decoder supports. The NMRA has simply „forgotten“ to define a mechanism for providing feedback from the decoder to the command station regarding the supported CVs.

With the introduction of the mfx® system the user does not have to deal with CVs, values and the binary system. The command station should rather request the decoder to provide this kind of information and then enable the user to enter any values in an easy way on the graphic interface.

For instance, you do not have to enter the value 15 in CV 3 on an mfx® capable command station but rather set the acceleration time to 10 seconds. Thanks to M4 you do not have to remember that CV 3 contains the value for the acceleration time and that the value 15 is equivalent to about 10 seconds. This kind of complex technology is hidden in the mfx® command station.

Therefore the mfx® system does not cater for a direct method of influencing the memory spaces, the so-called mfx® configuration area of the decoder. Generally, M4 only permits access via the command station.

This method has only one drawback. How can the owners of other command stations that are not mfx® capable access the configuration area? This is facilitated by means of a register concept that is somewhat similar to the NMRA DCC CVs. Unfortunately this does not provide access to all characteristics of the M4 decoder. Furthermore mfx® was not developed further as intended originally and basically remains at the status of 2004.

Since ESU “educated” the Central Station® 60212 with the “Reloaded” Update and taught it to support DCC and when Märklin® followed with the current Central Station 2, the situation has been somewhat eased: All current mfx® command stations also support DCC and can program DCC decoders. Since all LokPilot 5 decoders support DCC you now have the choice on how you wish to program your decoder:

- The Central Station® 60212 Reloaded and the Central Station 2 offer a graphic programming option for M4 decoders. However, it only recognises the “old” ESU LokPilot V3.5 decoders and their possibilities as well as the similar and hardly changed Märklin decoders. LokPilot 5 decoders can be programmed via this menu without any problems. Unfortunately some options are not available because the command station “does not know them”.

**i** In particular, the change of function key assignments (function mapping) is not possible. Here, the DCC programming must be used. The respective menus in the Central Station® are locked.

- You may access all options via DCC programming. If you own an ESU ECoS we recommend this kind of programming. This command station also provides a suitable profile for this decoder.

## 8.1.2. M4, the mfx® compatible protocol by ESU

Since the mfx® data protocol was introduced, it has been predicted by Märklin® as a trade mark. This is why ESU decided in January 2009 to use the name “M4” for all their decoders. M4 is technically 100% compatible with mfx®.

All ESU decoders and command stations which are M4 compatible can be easily combined with the corresponding Märklin®-mfx® products. We would like to apologise for this inevitable change of names due to reasons of trademark.

# M4

## 8.1.3. Configuration Variables (CVs)

LokPilot decoders follow the CV concept developed in the US. CV stands for „Configuration Variable“ and indicates that the storage cells described above are not only variable but they also determine the behaviour of the decoder.

### 8.1.3.1. Standardisation in the NMRA

The NMRA (National Model Railroad Association) has defined which CVs determine certain parameters of a decoder. The DCC standard allocates fixed numbers for certain CVs (adherence is obligatory). This greatly simplifies things for the user since decoders

of most manufacturers comply with this standard and therefore dealing with CVs requires the same process with the same CV-numbers regardless of the manufacturer.

The DCC concept permits to enter numbers ranging from 0 to 255 into CVs. Each CV carries only one number.

While the position number is predetermined, the range of values may vary. Not all CVs must accept values ranging from 0 to 255.

The permitted values for LokPilot decoders are listed in the table in chapter 21 showing all available CVs.

### 8.1.3.2. Bits and Bytes

Most CVs contain numbers: CV 1 for instance contains the locomotive address. This can be any number between 1 and 127. While most CVs expect numbers to be entered, some others are rather like a „collection point“ of various „switches“, that administer different functions in one CV (mainly „on“ or „off“): CVs 29 and 49 are good examples: you must calculate the value for these CVs yourself. The value depends on which settings you want to program:

Have a look at the explanations for CV 29 in the table in chapter 20.1.: firstly, decide which options should be active. The column „Value“ has two numbers for each option. If the option is switched off, the value is 0. Otherwise, it is a number between 1 and 128. Add all the values for the respective options to arrive at the correct value for this CV.

Example: Let us assume you want to run trains with the ECoS in DCC mode with 128 speed steps. Analogue detection should be active (because you also want to drive your locomotive in analogue mode). All other options are not active.

Therefore you must write the value 6 in CV 29 ( $0 + 2 + 4 + 0 = 6$ ).

## 8.2. Programming with popular Digital Systems

As already explained it is not possible to program every type of LokPilot with every command station in the market. This chapter explains which options are available.

### 8.2.1. Programming with DCC Systems

LokPilot decoders support all NMRA programming modes as there are the programming track modes (Direct Mode, Register Mode, Paged Mode) and the mode for the main („POM“, „Programming on the Main“).

Programming on the Main enables you to program your decoders comfortably without having to remove the locomotive from the layout. In this case, the command station talks directly to the decoder by using its locomotive address, for instance: „Locomotive number 50, write the value 7 into CV 3!“. Thus knowing the locomotive address is a precondition. Unfortunately, you cannot read CV values.

**i** However, with RailCom® you can read CV values on the main. More on this topic in chapter 16.

Assuming you have a suitable DCC system you can read CV values on the programming track. You can also reprogram the locomotive address without knowing the old address since the command station simply transmits the command „Write value 7 in CV 3!“. Each decoder receiving this command will execute it.

**i** ESU counts the bits from 0 to 7 as laid out in the standards while others (e.g.: Lenz®) count the bits from 1 to 8.

### 8.2.2. Programming with the ESU ECoS

Owners of an ESU ECoS can comfortably program LokPilot decoders. ECoS has a library of „Decoder Profiles“ that help you to program decoders with the graphic display. All CVs are stored in the decoder profile thus enabling the ECoS to read them and to display them on the screen. Chapter 15.5. of the ECoS manual provides more information on this topic.

**i** Please make sure that you always use the latest ECoS firmware version. Whenever we expand the range of the LokPilot family, only an update will add the required decoder profile.

### 8.2.3. Programming with Märklin® 6021

The Märklin® central unit 6021 works differently: Since it does not comply with the NMRA DCC standards, LokPilot decoders start a



special, obligatory programming procedure. Reading of values is not permitted.

There are two modes:

In the short mode, parameters with a number below 80 can be set provided the desired value is also lower than 80.

In the long mode, all parameters with values from 0 to 255 are adjustable. Since the display of the 6020/6021 is limited to two-digit numbers, values must be split and entered in two separate steps.

### 8.2.3.1. Changing to the Programming Mode

Enter the programming mode with the 6020/6021:

The throttle must be set to „0“. No other locomotives may be on on the layout. Watch out for flashing signals of the locomotive!

- Press the „Stop“ and „Go“ buttons of the 6021 simultaneously until a reset has been triggered (alternately pull the mains plug of the transformer). Press the „Stop“ button in order to switch off the track voltage. Enter the current decoder address. If you do not know the current address, simply enter „80“.
- Activate the change-of-direction button (turn the throttle knob to the left beyond the arrester until you hear a click sound), hold it in this position and then press the „Go“ button.



Please bear in mind that the 6020/6021 only permits you to enter values from 1 to 80. The value 0 is missing. Always enter „80“ instead of „0“.

### 8.2.3.2. Short Mode

The decoder is in the short mode (the headlights flash periodically in brief intervals).

- Now enter the number of the CV that you want to adjust e.g.: „01“. Always enter this number with two digits.
- For confirmation activate the change-of-direction routine (now the lights flash twice very quickly).
- Now enter the new value for the desired CV, e.g.: 15 (two digits).
- For confirmation activate the change-of-direction routine (now the lights light up for about one second).

- Then you can enter other CVs as desired.
- Selecting „80“ allows you to exit the programming mode. Alternately you can switch off the track voltage and then on again (press the „Stop“ button on the 6021, then the „Go“ button).

### 8.2.3.3. Long Mode

You access the long mode by entering the value 07 in CV 07 while in the short mode. The decoder confirms the change to the long mode by slowly flashing lights.

- Enter the hundred-digit and the ten-digit (decade) of the CV that you want to change. Example: If you want to adjust CV 124, you enter „12“.
- For confirmation activate the change-of-direction routine (now the lights flash periodically: long – short – long – short – etc.).
- Now enter the unit of the CV („04“ in this example).
- For confirmation activate the change-of-direction routine. Now the decoder expects the entry of the CV value. The lights flash periodically: long – short – short).
- Now enter the hundred-digit and the ten-digit (decade) of the new CV value (as a two-digit number). Example: You want to write the value 135. Therefore, you enter „13“.
- For confirmation activate the change-of-direction routine. Now the lights flash periodically: long – short – short – short).
- Now enter the unit of the new CV value as a two-digit number („05“ in this example).
- For confirmation activate the change-of-direction routine (now the lights light up for about one second).
- Now you can adjust more CVs in long mode.
- Exit the long mode by switching off the track voltage and then on again (press the „Stop“ button on the 6021, then the „Go“ button).

### 8.2.4. Programming with the Märklin® Mobile Station®

With the Mobile Station®, you can also adjust some of the CVs. Use the Register Programming Menu to facilitate this.



As with the 6021, you can only enter values between 1 and 80. The possible CV values are also limited to that range from 1 to 80. You will find the programming menu in the locomotive menu of the Mobile Station®. It is only available for certain locomotives. Of course, this works only for a programmable locomotive.

Proceed as follows:

- Enter a new locomotive in the database. How you do this is explained in the manual for the Mobile Station®:
- Select locomotive 36330. The locomotive Ex 3/3 is shown as active on the display.
- By pressing the „MENU / ESC“ button you can now change any of the settings such as name, address, etc. in the heading „CHANGE LOCOMOTIVE“. The last function shown is „Register Programming“ (REG). Select this for writing CVs.
- Then select the CV (called „REG“ on the Mobile Station®) and then the desired value and confirm by pressing the change-of-direction button.
- The Mobile Station® will program the new value into the decoder.



Please remove all locomotives which should not be programmed!

## 8.2.5. Programmierung with Märklin® Mobile Station 2

For programming with the Mobile Station® 2, please follow the instructions in their manual for programming DCC decoders.

## 8.2.6. Programming with the Märklin® Central Station

With the Central Station® 1 until software version 2.04, you can program the CVs 1 to 80 via the Motorola® programming menu. Unfortunately, you can only enter values between 1 and 80. Find more information regarding this programming mode in chapter 8 of the manual of the Central Station®.

Owners of a Central Station “Reloaded” or a Central Station 2 can program LokPilot decoders in DCC mode without any problems. With the CS1 “Reloaded” please proceed as described in the manual in chapter 17 (“Decoder programming”).

When using a Central Station 2, DCC programming is somewhat trickier.

- Establish a new locomotive manually. This must be done even if the decoder registers itself via mfx®. The locomotive address is not important in this context.
- Call up the new “Dummy” locomotive with a throttle.
- Open the menu “Edit locomotive” and select type “DCC”.
- Open the function “Edit locomotive”.
- Now enter all CVs you wish to configure in the list. Only then the command station will read out the values and save any changes.



Alternatively, you can program LokPilot 5 decoders, which have registered automatically, directly via the decoder menu. However, not all possibilities of the decoder may be offered. This compromise is required to serve all mfx® command stations on the market. In addition, these command stations assume that the decoders they are seeing are Märklin® decoders. When in doubt, use DCC programming.

## 8.2.7. Programming with the ESU LokProgrammer

The LokProgrammer 53451 offers the easiest and most comfortable way of setting the CVs of LokPilot decoders: simply by a few mouse clicks on an MS-Windows® computer. The computer saves you to look for the various CV numbers and values. More information is contained in the manual for the LokProgrammer.

You can access all properties of ESU decoders with the LokProgrammer. Since this works independently from the data format it also works for mfx® decoders.

Please use the software version from 5.0.0. onwards for the LokPilot 5 decoder. The software is available for download on our website!

## 8.2.8. Programming with the ROCO® Multimaus



Due to a severe firmware error the current LokPilot 5 decoder cannot be programmed with the Multimaus - firmware 1.00. In this case you must return your Multimaus to your dealer or directly to the ROCO® service for an update to version 1.02 or newer.

Unfortunately, due to another firmware bug that was fixed only in Version 1.04, the ROCO® Multimaus® is not able to program any CVs via number 255. To make, however, a proper programming procedure possible, we implemented an assistance tool. This helps to write the number of the CVs desired temporarily into two assisting CVs (so-called address registers), since the usual CVs cannot be reached. Afterwards the value of the CV desired will be programmed into another assisting CV (so-called value register). When the value register is written, the content will be copied to the actual desired position and the assisting CV will be set back.

Consequently, 3 CVs have to be programmed to write one CV. These 3 CVs mean the following:

CV	Name	Description	Range
96	Address offset	Saves the CV number that should be actually programmed in hundreds.	0 – 9
97	Address	Saves the CV number that should be actually programmed in units and tens.	0-99
99	Value	Saves the value of the CV that should be actually programmed.	0-255

Example: You wish to program CV 317 with value 120.

Proceed as follows:

- Programm the value of the CV number in hundreds in CV 96. In this example: CV 96 = 3.
- Programm the value of the CV number in units and tens in CV 97. In our example: CV 97 = 17.
- Programm the desired value in CV 99. In our example: CV 99 = 120.

As soon as you have programmed CV 99, the value of CV 99 will be transferred into CV 317. Is the programming finished, CVs 96, 97 and 99 will be set back automatically.

## 8.2.9. Programming with the ROCO® LokMaus II

The ROCO® LokMaus II is generally one of the most successful DCC command stations. However, as an affordable system designed for beginners it only allows the writing of two-digit CV numbers as well as CV values.

Similarly as with the MultiMaus® the problem can be solved via an assistance procedure. This helps to program the number of the CVs desired temporarily into two assisting CVs (so-called address registers) instead of programming the actual CV. Afterwards the value desired will be separated into two parts and programmed into two further assisting CVs (so-called value registers). When the last value register is written, the content will be copied to the respective desired position and all assisting CVs will be set back.

Consequently, 4 CVs have to be programmed to write one CV.

These 4 CVs mean the following:

CV	Name	Description	Range
96	Address offset	Saves the CV number that should be actually programmed in hundreds.	0 – 9
97	Address	Saves the CV number that should be actually programmed in units and tens.	0-99
98	Value offset	Saves the value of the CV that should be actually programmed in hundreds.	0-9
99	Value	Saves the value of the CV that should be actually programmed in units and tens.	0-99

Example: You wish to program CV 317 with value 120.

Proceed as follows:

- Programm the value of the CV number in hundreds in CV 96. In this example: CV 96 = 3.
- Programm the value of the CV number in units and tens in CV 97. In our example: CV 97 = 17.

# Address settings

- Programm the CV value in hundreds in CV 98. In our example: CV 98 = 1.
- Programm the CV value in untis and tens in CV 99. In our example: CV 99 = 20.

As soon as you have programmed CV 99, the value of CV 99 will be transferred into CV 317. Is the programming finished, CVs 96, 97,98 and 99 will be set back automatically.

## 9. Address settings

Each LokPilot decoder requires a definite address to be addressable for the central unit. Depending on the type of decoder and the digital system, there are several possibilities how to allocate addresses.

### 9.1. Short Addresses in DCC Mode

Normally you would control LokPilot decoders with the short address that is stored in CV 1. In DCC mode, the permitted values range from 1 to 127. In order to enable the decoder to „listen“ to the short address you must delete bit 5 in CV 29.



Some digital systems (e.g. ROCO® Lokmaus II, Lenz® digital plus, Lenz® compact) only support the values 1 – 99 as short address.

### 9.2. Long Addresses in DCC Mode

You can operate LokPilot decoders also with long addresses (4-digit addresses). The supported values range from 128 – 10239. The long address is stored in the CVs 17 and 18. You must activate the long address by setting bit 5 in CV 29.



Bit 5 in CV 29 switches between short and long address. The decoder can only respond to one address at a time.

If you want to use your LokPilot with the long address it is practical to program this address directly with your digital system: most modern digital systems (e.g. ESU ECoS, Bachmann E-Z Command® Dynamis®, ESU Cab Control) have a menu for programming long addresses. The command station not only programs CV 29 correctly but also assures the correct storage of the values for the long address in CV 17 and 18.

If you want to enter the long address manually in CV 17 and 18 please refer to chapter 21.1.

### 9.3. Motorola® Address

You can also operate many LokPilot decoders with the Motorola® format. The address for this operating mode is stored in CV 1.

This address is identical to the short address in DCC mode as described in chapter 9.1. The LokPilot decoder responds both to commands in DCC and in Motorola® mode at the same time. The permitted values are listed in chapter 7.2.2.2.



Märklin® digital devices (6020, 6021, Delta®) can only work with addresses from 1 to 80. Should you have entered a higher value in CV 1 you will not be able to drive this locomotive with these central units.

#### 9.3.1. Consecutive addresses for more functions

The extended Motorola®-Format covered only the lighting function (F0) and the auxiliary function F1 to F4. Of course, this is far too few for the many functions of the LokPilot 5.

Therefore one can assign up to three additional addresses (4 addresses in total). The so called consecutive addresses follow immediately after the actual address stored in CV 1 and serve to trigger functions. Motor control is solely accomplished via the base address in CV 1.

Example: You select the address 50 in CV 1 for a class 50 locomotive. You want to set 3 consecutive addresses. They are 51, 52 and 53. They will then switch the consecutive functions whenever you call up these addresses on your 6021:

Name	Example Address	Functions
Base address	50	F0, F1 – F4
Consecutive address 1	51 (50+1)	F5 – F8
Consecutive address 2	52 (50+2)	F9 – F12
Consecutive address 3	53 (50+3)	F13 – F16

# Address settings



Please make sure that no other vehicle is programmed to any of the consecutive addresses (in this example 51 to 53). Otherwise you will inadvertently run several vehicles at the same time!

The consecutive addresses are activated with bits 3 and 7 in CV 49. For reasons of compatibility they are not next to each other.

The relationship is as follows:

Bit 7	Bit 3	Meaning	Value to be added to CV 49
0	0	no consecutive address	0
0	1	Consecutive address 1 active	8
1	0	Consecutive address 1+2 active	128
1	1	Consecutive address 1+2+3 active	136

First read out the value in CV 49 (default value: CV 49 = 19) and the value shown in column 4. If, for instance, you wish to activate 3 consecutive addresses then you must write the value  $128 + 8 = 136$  into CV 49.



Consecutive addresses are only active in Motorola® mode.

## 9.4. Addresses in M4 mode

Even in an mfx® compatible system addresses are needed for controlling locomotives. However, they are assigned automatically by the command station when the locomotive reports to it for the first time. The addresses can neither be programmed manually by the user nor can they be read out.

## 9.5. Turning off data protocols not needed

If you know for certain on which layouts your locomotives will be “travelling” you can turn off the data protocols not needed. This is useful if multi protocol command stations lead to problems. CV 47 is responsible.

CV 47 Bit	Protocol	Value
0	DCC Protocol on	1
	DCC Protocol off	0
1	M4-Protocol on	2
	M4-Protocol off	0
2	Motorola®-Protocol on	4
	Motorola®-Protocol off	0
3	Selectrix®-Protocol on	8
	Selectrix®-Protocol off	0

Ex works all protocols are active (CV 47 = 15). In order to establish the value of CV 47, simply add all values in column 3 and write them into CV 47.



For safety reasons the protocol used for writing into CV 47 cannot be turned off. If you use, for instance, an ESU ECOS and write CV 47 in DCC format then the DCC protocol will remain on. If you use a 6021 then, of course, the Motorola® protocol cannot be turned off.



Programming with the ESU LokProgrammer cannot be turned off either.



LokPilot 5 DCC, LokPilot 5 micro DCC and LokPilot 5 L DCC do support the DCC system only regardless of the value stored in CV 47.

## 10. Adapting the Driving Characteristics

### 10.1. Acceleration and Deceleration

Acceleration and brake time can be set independently from each other. Therefore, you could for instance program a short acceleration and a much longer brake time.

The time for accelerating is adjusted in CV 3 while deceleration is set in CV 4. Permitted values are 0 (no delay) to 63.

The times set in these CVs work speed dependant. Therefore, the acceleration distance and the brake distance are longer at high speeds. In other words, the faster the locomotive moves, the longer it stops.



For information on how to set a brake distance independently of the speed refer to chapter 10.5.

#### 10.1.1. Switching Acceleration / Deceleration

LokPilot decoders can deactivate acceleration and deceleration by the push of a button. This is particularly handy for shunting since your locomotive responds directly to the throttle.

#### 10.1.2. Shunting Mode

The shunting mode reduces the speed (ex factory: to about 50%) for each speed step. Thus, you have smoother control of your locomotive in the lower speed ranges, which is important for shunting, particularly in the 14-speed-step mode. In CV 101 you can set the trim value or shunting mode.

### 10.2. VMin, Vmax, Speed Curve

LokPilot 5 decoders know internally 256 speed steps. They can be adapted to the characteristic of the locomotive and allocated to the actually available speed steps (14, 28, or 128).

The minimum speed can be set using CV 2. The maximum speed can be limited using CV 5.

Between speed step 1 and the maximum speed, LokPilot 5 decoders will superimpose the speed using a speed curve. The speed curve has 28 values (CV 67 to 94).



The CVs 67 and 94 are permanently set to the values of 1 respectively 255 in this decoder. The intermediate values can be distributed at will. The speed curve can not be switched off.

CV 2 and CV 5 define a scale factor around which the points of the speed curve are scaled. Have a look at the speed curve in Fig. 18. The last entry (CV 94) is 255. This represents full speed. If you wish to reduce the maximum speed you only have to reduce the value of CV 5. The decoder computes (squeezes) the speed curve in such a way that the shape of the speed curve remains despite the lower maximum speed.

The same is true for the first entry. The speed curve will be raised and scaled subject to the value in CV 2.

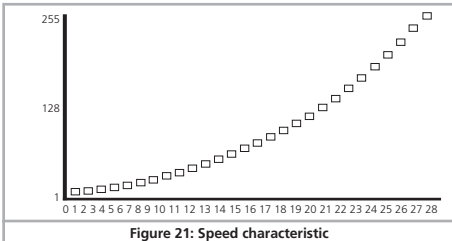

Figure 21: Speed characteristic

#### 10.2.1. 3-point speed table

LokPilot 5 DCC, LokPilot 5 micro DCC and LokPilot 5 L DCC support the NMRA 3-point speed table via CV 2, 5 and 6 also: Enter the start voltage in CV 2 and the maximum speed in CV 5. CV 6 corresponds with the speed at a medium speed step. Thus, you can define a "kink" in the speed curve. This mode is active if bit 4 = 0 in CV 29.

The values of the start, mid and maximum speed are dependent on each other. Selecting a mid speed that is lower than the start speed or higher than the maximum speed could lead to some erratic driving performance.

# Adapting the Driving Characteristics

Therefore always adhere to the principle: start voltage < mid speed < maximum speed.

## 10.3. Changing between Operating Modes

You may change from a digital to an analogue sector of your layout „on-the-fly“ at any time. The locomotive behaves as follows:

### 10.3.1. Changing from Digital to Analogue DC

When the decoder enters the analogue DC sector, it monitors the polarity of the track voltage. If the polarity (and the resulting direction of travel as per NEM) matches the the direction of travel in digital mode the locomotive will continue without stopping at the speed that corresponds to the analogue voltage.

If the polarity does not match than the behaviour depends on the settings in CV 27:

If the DC brake mode is active in CV 27 then the locomotive will slow down to a stop with the programmed deceleration, if not, then the locomotive will change the direction and back out of the analogue sector. Chapter 10.4. provides detailed info about brake sectors and the appropriate settings.

### 10.3.2. Changing from Digital to Analogue AC

If a locomotive travels into an analogue AC sector, it will continue onwards in the same direction at a speed corresponding to the analogue track voltage.

### 10.3.3. Changing from Analogue to Digital (directional bit)

When entering the digital sector the locomotive compares the current direction of movement with the digital signals arriving via the track: If the actual direction matches the one as per the digital signal, the locomotive continues onwards at a speed corresponding with the digital signals.

Does the direction not match the commands from the digital system, then the behaviour depends on the settings in the „directional bit“ (also refer to chapter 15.1. for more details):

If the directional bit has been set, then the decoder ignores the directional commands from the central unit, the locomotive conti-

nues in the same direction; only the speed will be adjusted according to the commands from the central unit. Therefore, the actual direction of movement does not match the direction as intended by the central unit for the time being; however, this changes once a change-of-direction-command is activated at the central unit.

If the directional bit has not been set, then the locomotive slows down and stops according to the programmed deceleration, changes its direction and returns to the conventional sector. What happens next is described in chapter 10.4.1 resp. 10.4.2.

### 10.3.4. Changing from Digital to Digital

Travelling between sectors with different digital protocols, namely Motorola® and DCC is possible at any time. The LokPilot decoder interprets each valid data package from the command station.

Travelling from Selectrix® to DCC or Motorola® is only possible after a short power interruption (also refer to chapter 7.2.3).

As mentioned in chapter 7.2.4 a change over from Motorola® or DCC to mfx® is possible at any time as soon as the decoder contains a valid mfx® packet. When changing from mfx® to Motorola® respectively to DCC (for instance, when a locomotive moves from a DCC controlled sector on the layout to one that is controlled by a 6021) the decoder accepts the Motorola® packets after about 4 seconds. During the first 4 seconds the locomotive will continue with the current speed and direction.

### 10.3.5. Changing modes with Analogue Mode turned off

Perhaps you have disabled analogue mode on your decoder (Bit 2 in CV 29 is deleted or CV 50 = 0). When the locomotive moves from the digital sector into the analogue one, the locomotive will continue with the set speed and direction. However, you cannot issue any commands to that locomotive until is back in a digital sector.

Under certain circumstances, the decoder interprets the analogue DC voltage as brake sector and slows down to a stop; please refer to chapter 10.4.

## 10.4. Brake Sectors

Brake sectors have the purpose to slow down the locomotive independently from the commands issued by the command station. Frequently, this function serves for stopping a train in front of a red signal. If a LokPilot detects a brake command, it will slow down with the programmed deceleration and then stop. After this enforced stop, the locomotive will accelerate again as per the programmed values in CV 3.

Depending on the type of digital system, there are several options on how to influence the decoder so that it stops the train.

### 10.4.1. DC Brake Mode

In order to activate the DC brake mode you must set bit 3 in CV 27. The LokPilot decoder will start brake once it moves from a digital sector into a DC sector provided the brake mode is active and the polarity of the track voltage does NOT match the current direction of travel. The locomotive will stop taking into account the programmed deceleration.

### 10.4.2. Märklin® Brake Mode

In principle, the Märklin® modules 72441 / 72442 apply a DC voltage to the track instead of the digital signals. Provided bit 3 and bit 4 in CV 27 is set, then LokPilot decoders detect this voltage and will stop the train (CV 27 = Value 24).



The signal generated by these modules looks the same as DC from conventional DC-transformers. The LokPilot could possibly misinterpret this and switch to the analogue mode instead of brake.



If you wish to control the LokPilot decoder with DCC signals and keep your Märklin® brake sectors then you should switch off the DC analogue mode by deleting bit 1 in CV 50. The LokPilot will stop as desired.

### 10.4.3. Selectrix® Diode Brake Sector

LokPilot decoders also detect the Selectrix®-diode brake sector and stop as desired.

### 10.4.4. Lenz® ABC Brake Mode

LokPilot 5 decoders supports the ABC braking technique. In order to use this function a group of anti-parallel diodes will be soldered to one half of the track. The resulting fall of voltage generates an asymmetrical DCC signal. LokPilot decoders are able to detect the potential difference between the left and right half of the signal. If desired, the decoder will be stopped.

To be able to use the ABC technique you also need, beside the adequate LokPilot decoder, an appropriate brake module. The ABC technique can only be operated with boosters offering an exact symmetrical output. All command stations and boosters by ESU and Lenz® guarantee a symmetrical output. We don't recommend to use other boosters for the ABC technique.

- If you wish to stop the LokPilot decoder when the track signal is stronger on the right side than on the left side (and the diodes are also installed on the left side), set bit 0 in CV 27.
- If you wish to stop the LokPilot decoder when the track signal is stronger on the left side than on the right side (and the diodes are also installed on the right side), set bit 1 in CV 27.
- If you want to stop the decoder no matter in which half of the track the diodes are set, please set bit 1 and bit 0 in CV 27 (CV 27 = 3)..

#### 10.4.4.1 ABC "slow approach" section

The decoders also detect "slow approach" sectors implemented with the Lenz BM2 module. The desired speed in the slow approach sector can be adjusted with CV 123. The value 255 corresponds with full speed while the value 0 would stop the locomotive.

#### 10.4.4.2. ABC detection threshold

In some operational situations it may happen that the LokPilot decoder does not detect the ABC braking section. This may be caused by the wiring or the boosters respectively the braking diodes. You can influence the detection sensitivity with the aid of CV 134. Change the default value (12) step by step and test until you achieve the desired result.



# Adapting the Driving Characteristics

## 10.4.4.3. ABC shuttle train control

In combination with the ABC technology, LokPilot 5 decoders allow a simple, command station independent shuttle train operation. For this purpose, an ABC brake module must ensure that the train is stopped at each end of the shuttle. The module must be installed in such a way that the locomotive is to brake in one direction on the left and on the other on the right (see section 10.4.4). With the help of the CV 149, the shuttle train can be activated if a residence time (Waiting time) > 0 seconds is set. Ask e.g. CV 149 = 20, the decoder will first decelerate when detecting an ABC braking distance, wait 20 seconds and then change the direction of travel. Since the braking section is only active for one side of the track, the locomotive will then start moving again. At the other end of the commute, the whole „game“ will start over when the brake section is detected. CV 149 equals 0 terminates the ABC shuttle train operation.

## 10.4.5. ZIMO HLU Brake Mode

By setting CV 27 bit 2, LokPilot 5 decoders can also respond to ZIMO's HLU commands. The maximum speed in the desired ranges can be specified exactly with the help of the CVs 150 to 154.

## 10.4.6. Brake Mode Exit Delay

Sometimes a bad rail contact can cause the brake signal from the decoder to no longer be detected correctly. In this case, the decoder would undesirably speed up again. CV 102 can be used to specify a delay value. Only when the decoder no longer detects a braking section for the time set there, the braking mode will be left.

## 10.5. Constant Brake Distance

An attractive function hides behind CV 254 (ESU brake mode): Here you can set a constant distance for braking the train, from the beginning of the brake sector to the stopping point. Thus, it is possible to stop the train right in front of a red signal regardless of the speed. The LokPilot simply calculates the required brake effect. The higher the value in CV 254, the longer is the brake distance. Simply make some trials on a test track in order to find the values

best suited to your locomotive.

If CV 254 is set to 0, then the normal time mode according to chapter 10.1. will automatically turn on.

The constant brake distance is only active in brake sectors. When you turn the throttle back to 0, the locomotive will slow down as per the value in CV 4.

Via CV253 you can chose how the LokPilot should decelerate.

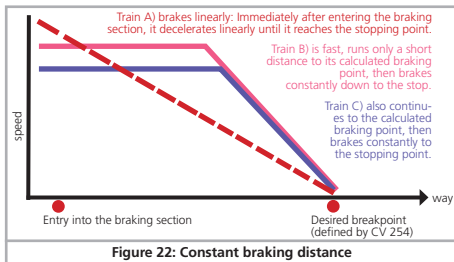

### 10.5.1. Linear Braking Distance

**CV253=0:** The loco starts immediately to stop linearly after receiving the braking command. The brake effort is determined by the decoder so that, independent from the starting speed, the loco will stop after reaching the way defined in CV254. The dashed line in Figure 22 shows the relation.

### 10.5.2. Constant Linear Braking Distance

**CV253>0:** Is the value in CV253 higher than 0, the locomotive continues to drive ahead for some time when entering the braking section to finally brake within the braking time indicated in CV253. The effort of the braking effect is now constant as set in CV253.

# Adapting the Driving Characteristics

The decoder changes the brake timing accordingly so that the locomotive stops at the correct position in the end. Figure 19 shows this quite clearly.

## 10.5.3. Push-pull trains

In order to assure that push-pull trains also stop at the correct point ahead of a red signal it is possible to set the braking distance for the reverse direction separately. This can be done with CV 255. If the value of CV 255 is greater than 0 then the value of CV 254 determines forward movement and CV 255 reverse movement. Typically the value for the reverse movement (driving trailer leads the train) is set for a shorter distance.

## 10.5.4. Braking at speed step 0

In order to apply the constant braking distance mode the decoder must generally detect a braking section. This may be disadvantageous, particularly when operation is computer controlled because the software transmits the "braking command" directly by setting speed step 0 even if there is no physical brake section. In order to assure that the LokPilot V 4.0 responds to the brake command with constant braking distance can be achieved by setting bit 7 in CV 27. This results in the decoder braking whenever speed step 0 is set.

## 10.6. Brake functions

LokPilot 5 decoders offer three brake functions to influence the braking time if desired. For each of the three braking functions you can individually set a percentage value, which is subtracted from the actual braking time (CV 4), as soon as the brake function is active. The brake functions work cumulatively, so that the braking time becomes shorter, the more braking functions are active. The brake functions can be mapped to any function key individually or together.

The shares to be deducted from CV 4 must be given in CVs 179, 180 and 181. The value 0 means 0%, the value 255 means 100%.

Example: The value 60 in CV 4 results in a regular braking time of 15 seconds. CV 179 is set to 90 for the brake function 1, CV 180 is set to 200 for brake function 2. If brake function 1 is active, this

results in a real braking time of  $60 \cdot (255-90)/255 = 39$ . If brake function 2 is active, the result is  $60 \cdot (255-200)/255 = 13$ . If the brake functions 1 and 2 are active results in  $60 \cdot (255-90-200)/255 = 0$  (negative braking values are not allowed!)

Normally, a brake function only affects the braking times, but does not initiate braking. For each brake function, there is now a CV (CV 182, CV 183 and CV 184) for defining the maximum speed with active braking function. This maximum speed can not be exceeded.

Example 1: You want the locomotive to decelerate to 0 when the brake function 1 is activated. Therefore write CV 182 = 0.

Example 2: You want the locomotive to decelerate while the braking function 2 is active, but not to exceed a minimum speed step of 8 (speed limit). Therefore write CV 183 = 8. In this case the locomotive will never drive faster than speed step 8, no matter how high the controller is turned up. However, if you turn it down manually, the locomotive will naturally slow down even more.

## 10.7. Load simulation

With LokPilot 5 decoders, other load conditions can be simulated at the press of a button next to the „normal“ load. The two logical functions „Optional Load“ and „Primary Load“ are used for this, both of which can be switched separately with any function key. The load condition for „Optional Load“ can be defined with CV 103, the load condition for „Primary Load“ can be defined with CV 104. The value 128 does not change, values <128 mean light load (e.g., empty), values > 128 are used for heavier load conditions.

The value of the CV affects both the CV 3 (acceleration times) and the braking value (CV 4).

The actual value of the acceleration and braking values can be calculated as follows:

Acceleration time = CV 3 \* (load value / 128).

Braking time = CV 4 \* (load value / 128).

# Adapting the Driving Characteristics

**Example 1:** You want to simulate a very heavy train and set CV 104 for „Primary Load“ to 220. CV 3 and CV 4 are set to 60. If the „Primary Load“ is active, the

acceleration and braking time =  $60 * (220/128) = 103$

**Example 2:** You want to simulate an empty run and therefore set CV 103 for „Optional Load“ to the value 32. For CV 3 and CV 4, set 60 again. If „Optional Load“ is active, the

acceleration and deceleration time =  $60 * (32/128) = 15$ .

Only one of the two load functions can be active at a time. If both buttons are pressed, the „heavy load“ has a higher priority and wins.

The load functions work cumulatively with the brake functions. This results in very realistic driving scenarios. Furthermore, the load functions affect the sound flow. If modeled by the sound designer, the noise will behave differently on a heavy train than on an empty run.

## 10.8. Settings for Analogue Operation

You can adjust the acceleration and maximum speed of the LokPilot separately for analogue DC and AC mode. Thus, you can adapt the speed of your locomotive also to analogue operations.

You will have to determine suitable values by trial and error since they depend on the type of transformer (throttle) and the drive system of your locomotive.

Please note that load compensation is always active ex works, even in analogue mode. This gives you smooth control even at very low speeds.

### 10.8.1. DC Analogue Operation

In DC analogue mode you can adjust the starting speed with the CVs 125 and the maximum speed with CV126.

The motor is switched off again as soon as the throttle voltage goes below a certain value. Normally this value is equal to the switch on voltage (CV 125) but can be lowered by an “Offset”. This offset is stored in CV 130.

Functions such as lights and sound can be turned on in advance

even when another (usually lower) voltage independent of the motor. To achieve this, the offset is written into CV 129.

The behaviour can be described as follows:

Motor on	CV 125
Motor off	CV 125 – CV 130
Functions on	CV 125 – CV 129
Functions off	CV 125 – CV 129 – CV 130

### 10.8.2. AC Analogue Operation

In AC analogue mode you can adjust the starting speed with CV 127 and the maximum speed with CV 128.

The motor is switched off again as soon as the throttle voltage goes below a certain value.

Normally this value is equal to the switch on voltage (CV 127) but can be lowered by an “Offset”. This offset is stored in CV 130.

Functions such as lights and sound can be turned on in advance even when another (usually lower) voltage independent of the motor. To achieve this, the offset is written into CV 129.

The behaviour can be described as follows:

Motor on	CV 127
Motor off	CV 127 – CV 130
Functions on	CV 127 – CV 129
Functions off	CV 127 – CV 129 – CV 130

## 10.9. Parking brake

If so desired the LokPilot decoder can short circuit the motor when the locomotive is stationary. This “parking brake” can prevent the inadvertent rolling away of the locomotive on a downhill gradient respectively reduce the curl.

The parking brake can be turned on by setting bit 6 in CV 124.

The parking brake is only active as long as track voltage is available.



## 10.10. Configure the PowerPack

When you connect an external capacitor or PowerPack, you are able to make the decoder switch off after a certain time. CV113 is responsible for that, since you are able to determine at what time the decoder is to switch off (as a multiple of 0.0328 seconds). You should set a time between 0.3 and 1.0 seconds to prevent your locos from driving too far during an emergency.



For the PowerPack to work, the function output responsible for the charge (typically AUX9 for LokPilot, AUX7 for LokPilot micro) must be configured to the „PowerPackControl“ function.

Set CV 31 = 16, CV 32 = 0 first.

Then set CV339 = 31 for LokPilot (AUX9)

Then set CV323 = 31 for LokPilot micro (AUX7).

## 11. Motor Control

6th generation load compensation enables LokPilot decoders to execute precise motor control. Even with the default settings, most locomotives run perfectly.

### 11.1. Adjusting Load Compensation

Should you find after programming and doing the initial test that the locomotive does not run smoothly particularly at low speed or that the locomotive jerks a little after having stopped or if you are simply unsatisfied with the driving performance, then you should adjust the load compensation of your LokPilot decoder.

Due to the large number of different types of motors and drive systems there is no single setting that suits all. Load compensation can be influenced with 10 CVs.



Firstly, check if the irregular performance is due to any mechanical faults. Bent driving rods are one common cause. When you turn off load compensation (set CV 49 Bit 0 to 0) and the problem persists then it is likely there is a mechanical fault.

#### 11.1.1. Parameter for frequently used Motors

We have listed the correct settings for the most common motors in table fig. 23 on the next page. If a motor is missing, it means

either that the default settings produce good results or that we have not yet sufficient experience about these motors.

Set the suitable values and test-drive your locomotive.

#### 11.1.2. Adjustments for other Motors / „Fine Tuning“

Unfortunately, the motors available in the market have considerable variations due to tolerances. This is even true for the same type. Therefore, LokPilot decoders enable you to adapt load compensation to the motor with CVs 51 to 56 and CVs 116 to 119. If the recommended values above do not lead to acceptable results, you can further optimise them.

Especially for the slow driving sector (speed step 1) the LokPilot 5 can change the gain control using CV 51 and CV 52. This helps to avoid any jerking while driving extremely slowly.

However, before doing this you must make sure that there are no capacitors wired between the motor terminals and the chassis.

The commutator of the motor must be clean and the drive system should run freely. The wheel contacts and other contact plates of the locomotive must also be clean and make reliable contact.

##### 11.1.2.1. Parameter „K“

Parameter „K“, stored in CV 54, influences how strongly load control will affect the driving performance. The higher the value, the more load control will respond to any changes and try to adjust the revs of the motor.

Parameter „K“ needs adjustment if the locomotive runs unevenly (jerks).

Reduce the value of CV 54 by 5 and test-run the locomotive to see if there are any improvements. Repeat these steps until the locomotive runs smoothly at speed step 1.

##### 11.1.2.2. Parameter „I“

Parameter „I“, stored in CV 55, provides important information to the decoder on how much inertia the motor has. Motors with large flywheels naturally have more inertia than smaller ones or coreless motors.

# Motor Control

Adjust parameter „I“ if the locomotive jerks somewhat just before it stops or „jumps“ at lower speeds (lower third of the speed step range) or simply does not run smoothly.

- Increase the value by 5 starting with the default value for motors with large flywheels.
- Reduce the value by 5 starting with the default value for motors with very small or no flywheels.

Test again and repeat this procedure until you arrive at the desired result.

## 11.1.2.3. Reference Voltage

In CV 53, you set the EMF reference voltage generated by the motor at maximum revs. This parameter may have to be adapted subject to the track voltage and the efficiency of the motor.

If the locomotive reaches maximum speed when the throttle is set to about three-quarter and the top third of the throttle has no influence on the speed, then you should reduce the value of CV 53. Reduce the value by 5 – 8 and test the locomotive again. Repeat this process until the locomotive just reaches its maximum speed when the throttle is fully open. On the other hand, if the locomotive moves too slowly at full throttle then you should increase the value of CV 53 step by step until the maximum speed is reached.

Motor type	Comment	CV 2	CV 9	CV 51	CV 52	CV 53	CV 54	CV 55	CV 56	CV116	CV117	CV118	CV119
Default settings	for ROCO, Liliput, Brawa	3	40	10	10	130	50	100	255	50	150	15	20
Fleischmann® Round motor		3	20	20	20	110	50	200	255	50	150	20	25
Märklin® little Disc collector motor	with Magnet 51961	4	20	15	30	80	20	200	255	50	150	20	25
Märklin® big Disc collector motor	with Magnet 51960	4	20	20	20	80	25	100	255	50	150	20	25
Märklin® Drum collector motor	with Magnet 51962	3	20	20	20	110	25	200	255	100	150	20	25
Märklin® 5*-High performance motor		3	20	20	20	110	25	200	255	100	150	20	25
Märklin® with Maxon Motor	Remove interference suppression capacitors!	3	50	10	0	120	115	50	255	50	150	20	20
HAG® Motors		3	20	20	15	100	40	150	255	50	150	20	25
Trix® with Maxon® Motors	Remove interference suppression capacitors!	3	50	10	0	120	115	50	255	50	150	20	20
Faulhaber® Motors		3	50	0	0	100	25	50	255	100	150	20	25
PIKO® 5-Pol Motors (new Motor)		3	25	15	20	110	30	40	220	50	100	10	25
PIKO® 3-Pol Motor (Hobby Motor)		4	25	15	20	120	25	50	220	50	80	10	25
Märklin® SoftDrive Sinus with Control board (PWM)	Switch off load control with CV 49 Bit 0 = 0	3	40	10	10	130	50	100	255	50	150	15	20
Bühler® Motor, generic		3	40	30	10	120	50	10	255	50	80	15	20
Bühler® Motor, Kiss Loks		3	40	32	0	140	30	100	240	80	120	15	20

Figure 23: Load regulation table for commonly used motors

## 11.1.2.4. Parameter "K slow"

The CV 52 separately controls the gain control for the slow driving sector in speed step 1. If you are not satisfied with the driving behaviour when the locomotive drives slowly or starts, while everything is fine with the medium and high speed steps, you should increase the value of CV 52 by approx. 5 - 10 than the value set in CV 54.

## 11.1.2.5. Parameter „K slow Cutoff“

CV 51 determines to which internal speed step the gain value defined in CV 52 is used. From the speed step mentioned here, the decoder calculates a characteristic and increases the gain up to the value set in CV 54.

## 11.1.2.6. Load control influence at slow speed

In CV 56 you can define the strength of the load control for low speed steps. If your locomotive does not run smoothly in the lower speed steps, reduce the value in CV 56.

## 11.1.3. EMF measurement principle

For the first time, it is possible to change the EMF measurement if necessary, in order to achieve a better driving behavior in problematic locomotives. In order for the LokPilot 5 to be able to control the motor, the motor is switched off at regular intervals and the EMF voltage (generator voltage of the motor) is measured. The more often this measurement takes place, the more accurate the control can be. The frequency of measurement is called „measurement period“.

In addition to the frequency of measurement, also the length of each individual measurement cycle (BEMF sampling period) is important. The longer it is measured, the sooner it is possible for disturbances to occur: Commutator brush fire for example adversely affect the quality of the measurement. The length of the measurement in each measurement period is called the „Measurement Gap“. Fig. 24 illustrates the relationship.

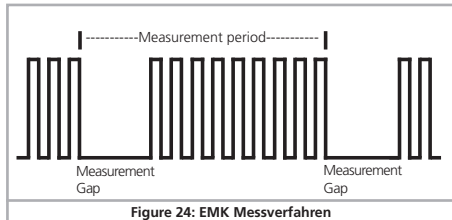

Figure 24: EMK Messverfahren

### 11.1.3.1. Measurement period

In CV 116, the length of the measuring period at speed 1 can be set in steps of 0.1 milliseconds. The value range of 50 to 200 thus allows measurement periods of 5 to 20 milliseconds.

In CV 117, the length of the measuring period at the highest gear can be set in steps of 0.1 milliseconds. The value range of 50 to 200 thus allows measurement periods of 5 to 20 milliseconds.

Normally the measuring period increases with increasing speed (so fewer measurements are made) so that the maximum motor power can be achieved at high speed.



For Coreless motors or other fast-moving engines with small or no flywheel, the measurement period can be reduced to achieve smoother running.

### 11.1.3.2. Measurement Gap

With the help of CV 118, the length of the Measurement Gap at speed 1 can be set in steps of 0.1 milliseconds. The value range of 10 to 40 allows Measurement Gaps of 1 to 4 milliseconds.

In CV 119, the length of the Measurement Gap at the highest gear can be set in steps of 0.1 milliseconds. The value range of 10 to 40 allows blanking intervals of 1 to 4 milliseconds.



Normally, the Measurement Gap becomes slightly larger at high speed in order to obtain more accurate measurement results.

Especially with old motors, a larger Measurement Gap can lead to more accurate readings, as interference can be smoothed out.

### 11.1.4. Automatic calibration of the motor

LokPilot 5 decoders offer a feature for automatic calibration of the motor. In most cases this procedure leads to excellent load compensation characteristics. However, due to the infinite number of possible combinations of motors and gear boxes a good result cannot be guaranteed in all cases. But it is certainly worth a try.

Proceed as follows:

- Set the vehicle onto a piece of straight and preferably level track. This track must be at least as long as to allow the locomotive to run at full speed for about two seconds. This movement takes place automatically during calibration. Provide buffer stops or something similar to prevent the locomotive from running off the track!
- Call up the locomotive on your throttle and make sure that F1 is switched off and the throttle is set to speed step 0. Set the direction of travel as desired.
- Write the value 0 into CV 54 (either on the programming track or with POM).
- Now press the "F1" button. The locomotive will start running at full speed automatically. During about 1.5 seconds you will not be able to control this locomotive!
- The locomotive will automatically stop and the identified load compensation parameters will be saved in the CVs 51, 52, 53, 54 and 55.

If you wish you can now further optimise the load control parameters starting from the calibrated settings.

### 11.2. Turning off Load Compensation

You can also switch off load compensation by setting CV 49, Bit 0 to the value of 0.



With load control turned off, the starting voltage in CV 2 should be increased until the locomotive starts moving at speed step 1 or 2.

### 11.3. Adapting Load Control Frequency

In the LokPilot decoders load control works with 40 kHz normally. Sometimes it can be useful to reduce this frequency by half:

- For motors with little power due to high inductivity.
- If suppressors (such as capacitors, chokes, etc.) disturb load control but cannot be removed (e.g. some older Gützold® locos).

The PWM frequency can be set in CV 9 as a multiple of 1000 Hz. The range of 10 to 50 allows frequencies from 10 kHz to 50 kHz.

### 11.4. Settings for the C-Sine Motors

LokPilot decoders with the 21MTC interface can drive Softdrive C-Sine motors indirectly via the circuit board installed in the locomotive. The LokPilot can generate all necessary signals provided you readjust certain settings:

Load compensation must be turned off as described in chapter 11.2.

The control electronics of the motor also need a switched logic voltage provided by the LokPilot on output AUX4. AUX4 must therefore be active while the locomotive is stopped and while it is moving (in both directions!).

Write the values below into the respective CVs.



Make sure that CV 31 contains the value 16 and CV 32 the value 8.

CV	Value
CV 257	48
CV 273	48
CV 289	48
CV 305	48

Use the LokProgrammer alternatively in order to activate AUX4 for the stationary locomotive and for the moving locomotive in both directions as shown in figure 25.

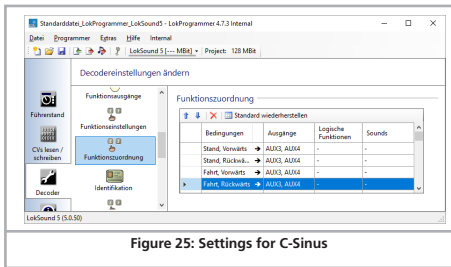

Figure 25: Settings for C-Sinus

Furthermore for certain models the serial interface (SUSI) must be activated since the control electronics receive their commands via this interface. Turn on SUSI by setting bit 3 in CV 124.

Based on the default value for CV 124 (20) you should now write 28 into CV 124.

Unfortunately there is another hurdle to be taken: The C-Sinus circuit board draws too much energy from the LokPilot decoder. If you have activated RailCom or Märklin brake sections there may be some erroneous behaviour. To rectify this connect a 470 µF capacitor between U+ and the common of the decoder as shown in chapter 6.12.

## 12. Function outputs

### 12.1. Available function outputs

LokPilot decoders have up to 22 physical function outputs. „Headlights“ and „Rearlights“ are used for lighting, the remaining ones are freely available. Other functions include „Shunting Mode“, „Acceleration / Deceleration On/Off“ as well as virtual functions like „Sound On/Off“ or „Brake function 1“.

The function buttons („F buttons“) of your command station or throttle activate the function outputs.

Generally, F0 is the lighting button, while we count the remaining buttons from F1 upwards.

### 12.2. Allocation of Function Buttons (Function Mapping)

You can allocate the functions freely to any function button. ESU uses the so-called and once more extended „Mapping“ for the LokPilot 5 decoder. It has the advantage that you can link each output to any button. Furthermore, the allocation can vary between forward and reverse as well. It is also possible to switch several functions simultaneously. Unfortunately this kind of flexibility requires a large amount of CVs. The NMRA has not reserved enough CVs for such cases. The solution of this problem is called „Index CV access“.

#### 12.2.1. Index CV access

The CVs ranging from 257 – 511 are „indexed“. This means that the meaning of any of these CVs can change depending on the value of the so-called „Index register“.

If you change the value of the index register, the meaning and the value of the CV itself will be also changed. This method allows to use every CV between 257–511 several times and solves the problem regarding CV shortage.

CV 31 and CV 32, which are also so-called „index register“, determines the meaning of CV 257–511 as well. If you change both the CVs 31 and 32, you simultaneously change the meaning and the values of CV 257–511.



The meaning of all other CVs (1–256) is not influenced by the value of the index register.

So should you ever change any of the CVs located in the range from 257, please make sure first that the index registers CV31 and CV32 have the indicated values.



At this state, CV 31 must always have value 16. CV 32 may have the values 0, 1, 2, 3 or 4.



## 12.2.2. Function Mapping Chart

The LokPilot 5 decoder offers powerful and flexible function mapping options:

- Each function button can switch as many outputs as desired.
- Each output can be activated by several function buttons.
- Function buttons can be linked (e.g.: F3 AND F5 pressed simultaneously).
- Function buttons can be inverted (e.g.: NOT when F8 is on).
- Besides the buttons F0 to F31 you can also incorporate the direction of travel or the speed (locomotive is moving / has stopped).
- You may connect as many as 5 external sensors.

While many model train enthusiasts need precisely these functions for optimal running of all their locomotives setting up function mapping represents so to speak the “free style” version of decoder programming. Take your time to understand the concept behind it before you start changing any settings.

All desired actions to be carried out by the decoder are saved in an internal table. Let's first have a look at the principal structure as it is shown in the chart on the next page. Two main groups can be seen:

- The input block (conditions block) shows which condition is required to achieve a certain output. Conditions are for instance “F3 On” or “Locomotive is stationary with direction set to forward, and F8 is switched on”.
- In the output block it is shown what action must be carried out when the condition(s) is/are met. This could be, for instance, switching a function output or a sound effect.

The table always has 72 entries, the so called “mapping rows”. The decoder works continuously through this table from top to bottom (row 1 to 72) and checks for each mapping row if the conditions set in the input block are met. ONLY THEN the decoder looks at the desired activities in the output block and carries them out. After that it jumps to the next row and once it has reached the bottom row it starts from the top again. This occurs several 100 times per second.

The conditions of each block are stored in CVs. There are 10 CVs per mapping row reserved for the input block and 7 CVs for the output block. The respective CVs responsible for each mapping row are listed in the table. These CVs are numbered from “A” to “Q” and are called control CVs.



Since all CVs are within the index area the appropriate value for CV 32 is also listed. Prior to changing any CVs you should ascertain that the index CVs are set to the values shown in the table.

Please note that the values shown for CV 32 can be different for the input block and the corresponding output block.

# Function outputs

Mapping row	Condition block (Input block)											Physical outputs			Logic functions			Sound functions				
	CV 32	CV A	CV B	CV C	CV D	CV E	CV F	CV G	CV H	CV I	CV J	CV 32	CV K	CV L	CV M	CV N	CV O	CV P	CV Q			
1	3	257	258	259	260	261	262	363	264	265	266	8	257	258	259	260	261	262	263			
2	3	273	274	275	276	277	278	279	280	281	282	8	273	274	275	276	277	278	279			
3	3	289	290	291	292	293	294	295	296	297	298	8	289	290	291	292	293	294	295			
4	3	305	306	307	308	309	310	311	312	313	314	8	305	306	307	308	309	310	311			
5	3	321	322	323	324	325	326	327	328	329	330	8	321	322	323	324	325	326	327			
6	3	337	338	339	340	341	342	343	344	345	346	8	337	338	339	340	341	342	343			
7	3	353	354	355	356	357	358	359	360	361	362	8	353	354	355	356	357	358	359			
8	3	369	370	371	372	373	374	375	376	377	378	8	369	370	371	372	373	374	375			
9	3	385	386	387	388	389	390	391	392	393	394	8	385	386	387	388	389	390	391			
10	3	401	402	403	404	405	406	407	408	409	410	8	401	402	403	404	405	406	407			
11	3	417	418	419	420	421	422	423	424	425	426	8	417	418	419	420	421	422	423			
12	3	433	434	435	436	437	438	439	440	441	442	8	433	434	435	436	437	438	439			
13	3	449	450	451	452	453	454	455	456	457	458	8	449	450	451	452	453	454	455			
14	3	465	466	467	468	469	470	471	472	473	474	8	465	466	467	468	469	470	471			
15	3	481	482	483	484	485	486	487	488	489	490	8	481	482	483	484	485	486	487			
16	3	497	498	499	500	501	502	503	504	505	506	8	497	498	499	500	501	502	503			
17	4	257	258	259	260	261	262	363	264	265	266	9	257	258	259	260	261	262	363			
18	4	273	274	275	276	277	278	279	280	281	282	9	273	274	275	276	277	278	279			
19	4	289	290	291	292	293	294	295	296	297	298	9	289	290	291	292	293	294	295			
20	4	305	306	307	308	309	310	311	312	313	314	9	305	306	307	308	309	310	311			
21	4	321	322	323	324	325	326	327	328	329	330	9	321	322	323	324	325	326	327			
22	4	337	338	339	340	341	342	343	344	345	346	9	337	338	339	340	341	342	343			
23	4	353	354	355	356	357	358	359	360	361	362	9	353	354	355	356	357	358	359			
24	4	369	370	371	372	373	374	375	376	377	378	9	369	370	371	372	373	374	375			
25	4	385	386	387	388	389	390	391	392	393	394	9	385	386	387	388	389	390	391			
26	4	401	402	403	404	405	406	407	408	409	410	9	401	402	403	404	405	406	407			
27	4	417	418	419	420	421	422	423	424	425	426	9	417	418	419	420	421	422	423			
28	4	433	434	435	436	437	438	439	440	441	442	9	433	434	435	436	437	438	439			
29	4	449	450	451	452	453	454	455	456	457	458	9	449	450	451	452	453	454	455			
30	4	465	466	467	468	469	470	471	472	473	474	9	465	466	467	468	469	470	471			
31	4	481	482	483	484	485	486	487	488	489	490	9	481	482	483	484	485	486	487			
32	4	497	498	499	500	501	502	503	504	505	506	9	497	498	499	500	501	502	503			
33	5	257	258	259	260	261	262	363	264	265	266	10	257	258	259	260	261	262	363			
34	5	273	274	275	276	277	278	279	280	281	282	10	273	274	275	276	277	278	279			
35	5	289	290	291	292	293	294	295	296	297	298	10	289	290	291	292	293	294	295			
36	5	305	306	307	308	309	310	311	312	313	314	10	305	306	307	308	309	310	311			

# Function outputs

Mapping row	Condition block (Input block)										Physical outputs			Logic functions			Sound functions					
	CV 32	CV A	CV B	CV C	CV D	CV E	CV F	CV G	CV H	CV I	CV J	CV 32	CV K	CV L	CV M	CV N	CV O	CV P	CV Q			
37	5	321	322	323	324	325	326	327	328	329	330	10	321	322	323	324	325	326	327			
38	5	337	338	339	340	341	342	343	344	345	346	10	337	338	339	340	341	342	343			
39	5	353	354	355	356	357	358	359	360	361	362	10	353	354	355	356	357	358	359			
40	5	369	370	371	372	373	374	375	376	377	378	10	369	370	371	372	373	374	375			
41	5	385	386	387	388	389	390	391	392	393	394	10	385	386	387	388	389	390	391			
42	5	401	402	403	404	405	406	407	408	409	410	10	401	402	403	404	405	406	407			
43	5	417	418	419	420	421	422	423	424	425	426	10	417	418	419	420	421	422	423			
44	5	433	434	435	436	437	438	439	440	441	442	10	433	434	435	436	437	438	439			
45	5	449	450	451	452	453	454	455	456	457	458	10	449	450	451	452	453	454	455			
46	5	465	466	467	468	469	470	471	472	473	474	10	465	466	467	468	469	470	471			
47	5	481	482	483	484	485	486	487	488	489	490	10	481	482	483	484	485	486	487			
48	5	497	498	499	500	501	502	503	504	505	506	10	497	498	499	500	501	502	503			
49	6	257	258	259	260	261	262	363	264	265	266	11	257	258	259	260	261	262	363			
50	6	273	274	275	276	277	278	279	280	281	282	11	273	274	275	276	277	278	279			
51	6	289	290	291	292	293	294	295	296	297	298	11	289	290	291	292	293	294	295			
52	6	305	306	307	308	309	310	311	312	313	314	11	305	306	307	308	309	310	311			
53	6	321	322	323	324	325	326	327	328	329	330	11	321	322	323	324	325	326	327			
54	6	337	338	339	340	341	342	343	344	345	346	11	337	338	339	340	341	342	343			
55	6	353	354	355	356	357	358	359	360	361	362	11	353	354	355	356	357	358	359			
56	6	369	370	371	372	373	374	375	376	377	378	11	369	370	371	372	373	374	375			
57	6	385	386	387	388	389	390	391	392	393	394	11	385	386	387	388	389	390	391			
58	6	401	402	403	404	405	406	407	408	409	410	11	401	402	403	404	405	406	407			
59	6	417	418	419	420	421	422	423	424	425	426	11	417	418	419	420	421	422	423			
60	6	433	434	435	436	437	438	439	440	441	442	11	433	434	435	436	437	438	439			
61	6	449	450	451	452	453	454	455	456	457	458	11	449	450	451	452	453	454	455			
62	6	465	466	467	468	469	470	471	472	473	474	11	465	466	467	468	469	470	471			
63	6	481	482	483	484	485	486	487	488	489	490	11	481	482	483	484	485	486	487			
64	6	497	498	499	500	501	502	503	504	505	506	11	497	498	499	500	501	502	503			
65	7	257	258	259	260	261	262	363	264	265	266	12	257	258	259	260	261	262	363			
66	7	273	274	275	276	277	278	279	280	281	282	12	273	274	275	276	277	278	279			
67	7	289	290	291	292	293	294	295	296	297	298	12	289	290	291	292	293	294	295			
68	7	305	306	307	308	309	310	311	312	313	314	12	305	306	307	308	309	310	311			
69	7	321	322	323	324	325	326	327	328	329	330	12	321	322	323	324	325	326	327			
70	7	337	338	339	340	341	342	343	344	345	346	12	337	338	339	340	341	342	343			
71	7	353	354	355	356	357	358	359	360	361	362	12	353	354	355	356	357	358	359			
72	7	369	370	371	372	373	374	375	376	377	378	12	369	370	371	372	373	374	375			

# Function outputs

## 12.2.2.1. Conditions block

Each condition block of each mapping row consists of 10 control CVs. Each CV defines four conditions.

Name	Description	Value
Control CV A	Locomotive drives	1
	Locomotive is stopped	2
	Direction is forward	4
	Direction is reverse	8
	Key F0 is On	16
	Key F0 is Off	32
	Key F1 is On	64
	Key F1 is Off	128
Control CV B	Key F2 is On	1
	Key F2 is Off	2
	Key F3 is On	4
	Key F3 is Off	8
	Key F4 is On	16
	Key F4 is Off	32
	Key F5 is On	64
	Key F5 is Off	128
Control CV C	Key F6 is On	1
	Key F6 is Off	2
	Key F7 is On	4
	Key F7 is Off	8
	Key F8 is On	16
	Key F8 is Off	32
	Key F9 is On	64
	Key F9 is Off	128
Control CV D	Key F10 is On	1
	Key F10 is Off	2
	Key F11 is On	4
	Key F11 is Off	8
	Key F12 is On	16
	Key F12 is Off	32
	Key F13 is On	64
	Key F13 is Off	128

Control CV E	Key F14 is On	1
	Key F14 is Off	2
	Key F15 is On	4
	Key F15 is Off	8
	Key F16 is On	16
Control CV F	Key F16 is Off	32
	Key F17 is On	64
	Key F17 is Off	128
	Key F18 is On	1
	Key F18 is Off	2
	Key F19 is On	4
	Key F19 is Off	8
	Key F20 is On	16
Key F20 is Off	32	
Control CV G	Key F21 is On	64
	Key F21 is Off	128
	Key F22 is On	1
	Key F22 is Off	2
	Key F23 is On	4
Control CV H	Key F23 is Off	8
	Key F24 is On	16
	Key F24 is Off	32
	Key F25 is On	64
	Key F25 is Off	128
Control CV H	Key F26 is On	1
	Key F26 is Off	2
	Key F27 is On	4
	Key F27 is Off	8
	Key F28 is On	16
	Key F28 is Off	32
	Key F29 is On	64
	Key F29 is Off	128

# Function outputs

Control CV I	Key F30 is On	1	
	Key F30 is Off	2	
	Key F31 is On	4	
	Key F31 is Off	8	
	Wheel sensor is On	16	
	Wheel sensor is Off	32	
Control CV J	Reserved	64	
	Reserved	128	
	Sensor 1 is On	1	
	Sensor 1 is Off	2	
	Sensor 2 is On	4	
	Sensor 2 is Off	8	
Control CV K	Sensor 3 is On	16	
	Sensor 3 is Off	32	
	Sensor 4 is On	64	
	Sensor 4 is Off	128	
	Control CV L	Sensor 1 is On	1
		Sensor 1 is Off	2
Sensor 2 is On		4	
Sensor 2 is Off		8	
Sensor 3 is On		16	
Sensor 3 is Off		32	
Control CV M	Sensor 4 is On	64	
	Sensor 4 is Off	128	

The value to be written into each control CV is easily established: simply add the values of the desired conditions.

**Example:** You want F0 to be switched on while the locomotive is stationary and set to direction forward and while F4 is switched off. Therefore you write the value  $4 + 16 = 20$  into the control CV A and the value 32 into the control CV B. All other CVs remain on 0. Thus these conditions are ignored. The previous table shows into which CVs you have to write the values. The input block for the first mapping row lies between CV 257 (control CV A) and CV 265 (control CV I).

LokPilot 5 decoders support up to 5 sensor inputs. Based on the decoder type, not all sensor inputs may be available or need to be enabled in the software first. Please refer to table 5.1.6. for details.



Nevertheless you can use them in mapping because these sensors could be on add-on circuit boards (e.g.: as is the case in the locomotives of the ESU Engineering Edition).

## 12.2.2.2. Physical function outputs

Physical function outputs are outputs that are actually built into the decoder where you can connect “real” loads by means of wires. The actual outputs of each decoder are shown in the table on page 36.



Nevertheless you can map all outputs since additional outputs could be installed on separate circuit boards (e.g.: ESU I/O expansion circuit board). They are fully integrated into the function mapping.

The block for the physical outputs of each mapping row covers three CVs. The meaning of those CVs is as follows:

Name	Description	Value
Control CV K	Output Headlight On [Conf. 1] 1	1
	Output Rearlight On [Conf. 1] 2	2
	Output AUX1 On [Conf 1.] 4	4
	Output AUX2 On [Conf 1.] 8	8
	Output AUX3 On 16	16
	Output AUX4 On 32	32
Control CV L	Output AUX5 On 64	64
	Output AUX6 On 128	128
	Output AUX7 On 1	1
	Output AUX8 On 2	2
	Output AUX9 On 4	4
	Output AUX10 On 8	8
Control CV M	Output AUX11 On 16	16
	Output AUX12 On 32	32
	Output AUX13 On 64	64
	Output AUX14 On 128	128
	Output AUX15 On 1	1
	Output AUX16 On 2	2
Control CV N	Output AUX17 On 4	4
	Output AUX18 On 8	8
	Output Headlight On [Conf. 2] 16	16
	Output Rearlight On [Conf. 2] 32	32
	Output AUX1 On [Conf 2.] 64	64
	Output AUX2 On [Conf 2.] 128	128

# Function outputs

You must add the value for the control CV for each output you want to switch. Into which CV exactly you must write a value you can find in the overview table on page 56. For mapping row 1 they are, for instance, CVs 257 (control CV K), CV 258 (control CV L) and CV 259 (Control CV M).



Note that these CV numbers have already been used for the conditional block (Control CV A, B, C), but are on a different page (value for CV 32 is different). Always pay attention to the correct value of CV 32 before writing!



The lighting outputs Headlight and Rearlight as well as the outputs AUX1 and AUX2 are duplicated. These outputs can be configured twice (configuration [1] and configuration [2]). Thus you can determine by pressing the appropriate function button which of the two possible configurations should be active. This enables you, for example, to set up upper beam and lower beam headlights (bright and dim). Please refer to chapter 12.5.1. for more information.

### 12.2.2.3. Logic Functions

Under the heading Logic functions we have compiled all functions that either directly or indirectly “dynamically” influence the behaviour of the decoder. Often these functions are only effective in conjunction with other settings.



Do not confuse logic functions with logic outputs. Logic outputs are physical function outputs, while logic functions are only software-controlled additional functions.

The following functions are envisaged:

- Drive Hold: This function keeps the speed constant. Throttle changes do only influence the sound, not the real locomotive speed.
- Uncoupling cycle: The locomotive will automatically push the train and then pull back as explained in section 12.5.7.
- Shunting mode: the locomotive moves at the speed defined in CV 101.
- Switching off acceleration and braking deceleration delay.
- Brake functions 1 – 3: The braking time is set as explained in section 10.6.
- Fire box: if set, an LED simulating the fire box varies the brightness.
- Dimmer: if set, all outputs are dimmed to about 60% darker provided the outputs have been set to “Dimming down”.
- Grade crossing: sets the grade crossing function for the appropriately configured outputs for American models.

# Function outputs

As is the case with the physical outputs the logic functions are also represented by three CVs in the mapping row. The arrangement within the CVs is as follows:

Name	Description	Value
Control CV N	Alternative Load	1
	Shunting Mode On	2
	Brake Function 1 An	4
	Brake Function 2 An	8
	Brake Function 3 An	16
	Heavy Load	32
	Uncoupling cycle	64
	Drivehold	128
	Control CV O	Fire box
Dimmer		2
Grade Crossing		4
Disable Acceleration&Braking times		8
Reserved		16
Reserved		32
Reserved		64
Reserved		128

You must add the value for the control CV for each output you wish to switch. Into which CVs exactly you must write these values you can find in the overview table on page 56. For mapping row 1 they are, for instance, CVs 260 (control CV N), CV 261 (Control CV O).

## 12.2.2.4. Virtual Driving sound

If desired, the LokPilot 5 can delay the start of the locomotive: The locomotive only starts after the time set in CV 252 (resolution: 65ms).

This is used to synchronize locomotives with LokPilot decoders that are operated in multiple traction.

However, the delay should only be active if the sound function is activated on the LokPilot decoder. The „Virtual Driving Sound“ function is used for this: Map this function to any key to virtually switch the sound (and thus the delay) on and off.

Name	Description	Value
Control CV Q	Soundslot 1 („Virtual sound“)	1

## 12.3. Default mapping LokPilot 5

All LokPilot 5 decoders (regardless of their size) have an identical function key assignment at the factory. The table on page 62 provides information on the basic assignment.

## 12.4. Allocation of Function Keys with the LokProgrammer

Although programming the function outputs with the aid of an ESU ECoS respectively with any other DCC compliant command station is possible this procedure can be handled far easier with the ESU LokProgrammer and a PC. Its graphic interface simplifies the assignment of functions considerably. We recommend using the software version 5.0.0. in order to be able to utilise all potential options.

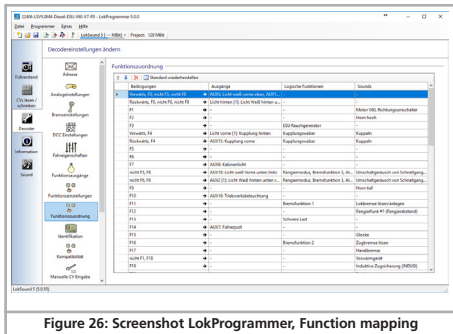

Figure 26: Screenshot LokProgrammer, Function mapping

## Default mapping LokPilot 5 Decoder

Line	Condition block	Description	Physical outputs	Logical functions
1	FS, fwd	Stop, Forward		
2	FS, rev	Stop, Reverse		
3	FF, fwd	Run, forward		
4	FF, rev	Run, reverse		
5	F0, fwd	Light button, forward	Light in front	
6	F0, rev	Light button, backward	Light behind	
7	F1	Key F1	AUX1[1]	
8	F2	Key F2	AUX2[1]	
9	F3	Key F3		Shunting mode
10	F4	Key F4		Acceleration/braking time off
11	F5	Key F5	AUX3	
12	F6	Key F6	AUX4	
13	F7	Key F7	AUX5	
14	F8	Key F8	AUX6	
15	F9	Key F9	AUX7	
16	F10	Key F10	AUX8	
17	F11	Key F11	AUX9	
18	F12	Key F12	AUX10	
19	F13	Key F13	AUX11	
20	F14	Key F14	AUX12	
21	F15	Key F15	AUX13	
22	F16	Key F16	AUX17	
23	F17	Key F17	AUX18	
24	F18	Key F18		
25	F19	Key F19		
26	F20	Key F20		
27	F21	Key F21		
28	F22	Key F22		
29	F23	Key F23		
30	F24	Key F24		
31	F25	Key F25		
32	F26	Key F26		
33	F27	Key F27		
34	F28	Key F28		
35	F29	Key F29		
36	F30	Key F30		
37	F31	Key F31		



# Function outputs

## 12.5. Function output configuration

Each function output can / must be unlocked prior to using it. Furthermore, each output can be set to a certain effect and can be combined with the global functions "Grade crossing", "Dimmer" and "Fire box".

Effects are divided into lighting effects and special effects.

The behavior of each function output is specified with 7 controlling CVs per each function output, as shown in this table:



Please set index register CV 31 to 16 and CV 32 to 0 before changing any of the above-mentioned CVs.

Output	Mode Select CV	Switching-On/-Off Delay	Automatic Switch Off	Brightness CV	Special Function CV1	Special Function CV2	Special Function CV3
Light front (Config. 1)	259	260	261	262	263	264	258
Light back (Config. 1)	267	268	269	270	271	273	266
AUX1 (Config. 1)	275	276	277	278	279	280	274
AUX2 (Config. 1)	283	284	285	286	287	288	282
AUX3	291	292	293	294	295	296	290
AUX4	299	300	301	302	303	304	298
AUX5	307	308	309	310	311	312	306
AUX6	315	316	317	318	319	320	314
AUX7	323	324	325	326	327	328	322
AUX8	331	332	333	334	335	336	330
AUX9	339	340	341	342	343	344	338
AUX10	347	348	349	350	351	352	346
AUX11	355	356	357	358	359	360	354
AUX12	363	364	365	366	367	368	362
AUX13	371	372	373	374	375	376	370
AUX14	379	380	381	382	383	384	378
AUX15	387	388	389	390	391	392	386
AUX16	395	396	397	398	399	400	394
AUX17	403	404	405	406	407	408	402
AUX18	411	412	413	414	415	416	410
Light front (Config. 2)	419	420	421	422	423	424	418
Light back (Config. 2)	427	428	429	430	431	432	426
AUX1 (Config. 2)	435	436	437	438	439	440	434
AUX2 (Config. 2)	443	444	445	446	447	448	442

# Function outputs

The seven CVs have the following meaning:

- Mode Select: Defines which effect you want to have for the output.
- Switch-on and switch-off delay: Defines the time by which switch-on and switch-off is delayed.
- Automatic switch off: Time after which the output is automatically turned off. This is useful for automatic couplers that should be turned off after a certain time regardless of the function key state.
- Brightness: Defines the brightness of each individual function output in 32 steps (0 to 31).
- Special functions CV1 to CV3: Defines some further modes for each special effect. Described below.

## 12.5.1. Available lighting effects

The following lighting effects are available:

- Dimmable light: A normal continuous output. The brightness will be reduced to about 50% if the dimmer function is on.
- Dimmable headlight with "fade in/out": Here the output is switched on slowly and imitates the slow glowing of oil lamps or very old light bulbs. The brightness will be reduced to about 50% if the dimmer function is on.
- Firebox: Simulates a normal fire box lighting effect.
- Intelligent firebox: Simulates an "intelligent" fire box lighting effect, whose intensity changes if the Logic function "Firebox" is active.
- Single Strobe: This is a single strobe light (short flashing) output. The frequency can be adjusted.
- Double Strobe: This will result in two short flashes. The frequency can be adjusted.
- Rotary Beacon: This effect should simulate a revolving reflector and bulb assignment of a very popular warning beacon atop many diesels of the 60's and 70's.
- Prime Stratolight: This is the more modern version of the Redary beacon.

- Ditch Light Type 1: The ditch light type 1 will revert to a steady On state when it is not flashing.
- Ditch Light Type 2: The ditch light type 2 will revert to Off state when it is not flashing.
- Oscillator: A warning signal required in the USA.
- Flashing light: This is the "classical" flashing light. The frequency can be adjusted.
- Mars Light: This effect simulates the sweeping pattern of this well-known warning beacon in the USA.
- Gyra Light: The Gyra Light is similar to the Mars Light, but is slower in motion.
- FRED: „Flashing End of Train Device“: simulates the flashing red light indicating the end of a train in America.
- Fluorescent lamp: simulates the typical starting characteristics of a fluorescent lamp.
- Energy saving lamp: simulates the typical starting of modern energy saving lamps.

The following special functions are available:

- Fan control: here a small electric motor is slowly run up to high revs and then back down again. This is often used for fan motors that continue to run for a while.
- Seuthe® smoke generator: the intensity is reduced whenever the locomotive is stationary.
- Servo: an RC servo can be connected to this output. Not available for all outputs.
- Conventional coupler function: You can use this function to control Krois® couplers, also in connection with automatic pushing/removing.
- ROCO® coupler function: You can use this function to control ROCO® couplers, also in connection with automatic pushing/removing.

# Function outputs

- **Panto:** this function is needed for ESU locomotives with functional pantographs.
- **PowerPack Control:** Controls the charging and discharging of the external PowerPack. Must be selected when a PowerPack is connected. Also note section 6.12.2.
- **ServoPower Control:** Can control the external power supply for Servo5 and Servo6: Active only when the servos are in motion.

## 12.5.2 How to configure the outputs

In order to set each output, you should proceed as follows:

1. From the table on page 66, select the value for the Mode Select CV.
2. Compute the value for the Special Function CV 1 by adding the values you can find in that table to the corresponding special function.
3. Define the value for the desired brightness.
4. Write the values into the CV corresponding to the appropriate function output.

Repeat these steps for all function outputs you want to configure

**Example:** Double Strobe with LEDs on AUX4 for LokPilot 5 Decoders. We want to set up AUX4 to create a Double strobe output. We want to use an LED.

1. Using the table on page 66, we find that the Mode Selection CV must be set to 6.
2. We find out that for LED compensation mode, we should set the Special function CV to 128.
3. We want to have a brightness level of 25.
4. Using the table on page 63, we find that the Mode Select CV for AUX4 is 299. We set CV 299 = 4. We also find that the brightness CV is 302 and set it to 25. Finally, the Special function CV for AUX4 is 303 and needs to be set to 128.



Please set index register CV 31 to 16 and CV 32 to 0 before changing any of the above-mentioned CVs .

### 12.5.2.1. Special Functions 1 and 2

Depending on the desired lighting effect, it may be necessary to configure the „Special function CV 1“ in more detail. The following options are available:

- **Phase Select:** Alters the timing of the effect so that it is 180 degree out of phase with other effects. This allows you to create alternate blinking.
- **Grade Crossing:** Causes the lighting effect to become active only when the global flag “Grade crossing enable” is set AND the corresponding function key is ON. Grade crossing logic can be used with any of the light effects. Grade Crossing can be used with most of the lighting effects.
- **Rule 17 Forward:** Applicable only if the output is set to either “Dimmable headlight” or “Dimmable headlight with fade in / out”. Causes the effect to be dimmed to around 60% of the set brightness, if the locomotive is stopped. When the engine is running forward, the output will be increased to a 100%.
- **Rule 17 Reverse:** Like Rule 17 Forward, but the brightness will be increased to a 100% when the locomotive drives backwards.
- **Dimmer:** Causes the output to be dimmed to around 60% of the defined brightness, if the global flag “Dimmer” is set. With this function you are able to realise a full beam very easily by setting the the global function “Dimmer” with a function key (compare chapter 12.5.1).
- **LED mode:** The light outputs are pre-set to be used with incandescent bulbs. If you wire LEDs on the output, you should set this option in order to let the decoder know about it. The light effects will be accordingly adjusted, so that the result will look more realistic again.

# Function outputs

Lighting effect	Mode Select	Switching-on/-off delay	Automatic Switch-Off	Brightness		
					Value	
Dimmable light	1	0 – 255	0 – 255	Brightness	0 – 31	
Dimmable light („Fade in/out“)	2	0 – 255	0 – 255	Brightness	0 – 31	
Firebox	3	0 – 255	0 – 255	Brightness	0 – 31	
Intelligent firebox	4	0 – 255	0 – 255	Brightness	0 – 31	
Single Strobe	5	0 – 255	0 – 255	Brightness	0 – 31	
Double Strobe	6	0 – 255	0 – 255	Brightness	0 – 31	
Redary Beacon	7	0 – 255	0 – 255	Brightness	0 – 31	
Strato Light	8	0 – 255	0 – 255	Brightness	0 – 31	
Ditch Light Type 1	9	0 – 255	0 – 255	Brightness	0 – 31	
Ditch Light Type 2	10	0 – 255	0 – 255	Brightness	0 – 31	
Oscillator	11	0 – 255	0 – 255	Brightness	0 – 31	
Flashing light	12	0 – 255	0 – 255	Brightness	0 – 31	
Mars Light	13	0 – 255	0 – 255	Brightness	0 – 31	
Gyra Light	14	0 – 255	0 – 255	Brightness	0 – 31	
FRED	15	0 – 255	0 – 255	Brightness	0 – 31	
Fluorescent lamp	16	0 – 255	0 – 255	Brightness	0 – 31	
Energy saving lamp	17	0 – 255	0 – 255	Brightness	0 – 31	
Single Strobe Random	18	0 – 255	0 – 255	Brightness	0 – 31	
ESU coupler 1 (for compatibility)	21					
ESU coupler 2 (for compatibility)	21					
Reserved						
Fan control	23	0 – 255	0 – 255	fan speed	0 – 31	
Seuthe® Smoke unit	24	0 – 255	0 – 255	Intensity	0 – 31	
Reserved						
Reserved						
Servo1, Servo2 Servo3, Servo4 Servo5, Servo6	27	0 – 255	0 – 255	Run time „A“	0 – 63	Run time „B“ in Special function CV3
Conventional coupler function	28	0 – 255	0 – 255			
ROCO® coupler function (**)	29	0 – 255	0 – 255			
Panto control	30	0 – 255	0 – 255	End position Panto	0 – 15	
PowerPack Control	31	0 – 255	0 – 255			

# Function outputs

Special function CV1						Special function CV 2	Remarks
Change Phase	Grade XING	Rule 17 Fw	Rule 17 Rev	Dimmer	LED Mode		
		4	8	16	128		Available for all outputs
		4	8	16	128		Available for all outputs
					128		Available for all outputs
					128		Available for all outputs
1	2				128		Available for all outputs
1	2				128		Available for all outputs
1	2				128		Available for all outputs
1	2				128		Available for all outputs
1	2				128		Available for all outputs
1	2				128		Available for all outputs
1	2				128		Available for all outputs
1	2				128		Available for all outputs
1	2				128		Available for all outputs
1	2				128		Available for all outputs
						Startup time (0 – 255)	Available for all outputs
						Startup time (0 – 255)	Available for all outputs
							Available for all outputs
							Only AUX7, AUX15
							Only AUX8, AUX16
Acceleration time (0 – 31 )						Braking time (0 – 31)	Available for all outputs
Heater power at speed step 1 (0 – 31)						Heater power Vmax (0 – 31)	Available for all outputs
End position „A“ (0 – 63)						End position „B“ (0 – 63)	Servo1 only AUX15, Servo2 only AUX16 Servo3 only AUX17, Servo4 only AUX18 Servo5 only AUX11, Servo6 only AUX12
coupler strength (power) (0 - 31)							Available for all outputs
							only AUX1[1],AUX1[2],AUX2[1],AUX2[2]
							only AUX9, AUX10 für Engineering Edition
							Available for all outputs

## 12.5.3. Grade Crossing holding time

You can define the hold time for the global grade crossing function as you like. By doing so, the "Grade Crossing" will remain active, also after switching off the function key. This will create a very interesting game effect. The desired value will be stored in CV 132. The value of CV 132 multiplied with 0.065 seconds defines the time. The default value 80 results in 5.2 seconds.

## 12.5.4. Flash rate

You can also set the flash rate for all lighting effects globally. All effects will flash or strobe at the same rate. The desired value should be stored in CV 112. The value of CV 112 multiplied with 0.065536 seconds (65,536ms) defines the flash rate. The default value 20 results in 1.00 seconds.

## 12.5.5. Automatic Switch-off

Each output usually switches off when the corresponding key is deactivated. However, sometimes the output has to be "forced" to switch off after a certain period of time to avoid damages.

Digital couplers by ROCO® e.g. cannot handle permanent control. Via the automatic switch-off function you are able to determine for every output when it should be switched off automatically - no matter if the function key is still activated.

Just write the time, after which the output should be switched off, into the corresponding CV according to the above table. The unit is 0.4 seconds. The default value „0" deactivates this function.

## 12.5.6. Switch-on and switch-off delay

You can set switch-on and switch-off delays for each output separately.

- The switch-on delay causes the function to switch on only after the predetermined time has lapsed.
- The switch-off delay causes the function to be turned off only after the predetermined time has elapsed.

Both time periods can be individually set in steps from 0 – 15 and are then written into their common control CV.

Description	Range	Time in seconds	Bits within the Control CV
Switch-on delay	0-15	0-6,144 seconds	0-3
Switch-off delay	0-15	0-6,144 seconds	4-7

The value to be written into the control CV is established as follows:

Switch-off delay \* 16 + switch-on delay

Example: The switch-on delay for AUX3 should be = 13; switch-off delay equals 8, thus  $8 * 16 + 13 = 141$  must be written into the Control CV 292.

## 12.5.7. Digital Couplers

LokPilot 5 decoders can directly control digital couplers. Subject to the type of coupler, you must adjust certain settings.

### 12.5.7.1. Coupler Mode

Krois® and ROCO® couplers need a special high frequency PWM signal to avoid burning the copper windings of the coil. This special function „Coupler" provides this type of signal. In this mode, the output turns on at 100% for 250 ms and then reduces the output power by switching to the PWM-signal. The ratio between Off and On time can be set by adjusting the „Brightness Value" from 0 (completely off) to 31 (connected through = 100% output).

This coupler mode should also be used for modern Telex®-couplers.

### 12.5.7.2. Automatic Coupler Function (Removing/Pushing)

LokPilot 5 decoders are able to do the automatic decoupling. When you push the function button the loco drives backwards against the train and then removes from it again. This procedure can be influenced via three CVs.

# Function outputs

In [CV 246](#) the speed that moves the loco will be stored (or defined) (0-255). If this value is 0, the automatic coupler function is not active.

In [CV 247](#) the time of removing is to be entered.

In [CV 248](#) the time of pushing is to be entered.

The time of removing should be higher than the time of pushing to make sure that the loco stops in a safe distance away from the train.

The function output of the option „coupler“ needs to be configured correctly to make the automatic decoupling work.

## 12.5.8. Servo settings

For the servos to work properly, they must be configured after the correct connection. Note chapter 6.9.6. or chapter 6.9.7. to find out how the servos are connected.

As can be seen in the table on page 66, the desired „runtime A“ is entered as a multiple of 0.25 seconds in the „Brightness CV“. The „Runtime B“ is entered as multiples of 0.25 seconds in the „special function CV 3“.

The end position „A“ is entered in the „special function CV 1“ and the end position „B“ in the „special function CV 2“.



The servos „Servo5“ and „Servo6“ can be used on all decoders as an alternative to the SUSI control pins. If you want to use these outputs, you must ensure that SUSI is off (set CV 124, bit 3 to zero).

## 12.6. Input configuration for wheel sensor LokPilot 5 H0

LokPilot 5 decoders support up to 5 sensor inputs that can be used to turn on functions. The table page 28 shows the available sensor inputs per each decoder type.

An important exception is the LokPilot 5 H0 decoder. The wheel sensor input is shared with AUX10. If the wheel sensor is to be used, CV 124, bit 4 must be set. For safety reasons you should also switch off the AUX10 by writing CV 339 = 0 (set CV 31 = 16, CV 32 = 0 before).

## 12.7. Analogue Settings

With the CVs 13 and 14, you can predetermine which function buttons should be switched in analogue mode. Thus, you „simulate“ pressing an F button. The ex works default settings switch on the directional headlights (F0 is on!) as well as F1 (ex works allocated to AUX1).

### Analog Function Control 1

CV #	F1	F2	F3	F4	F5	F6	F7	F8
13	1	2	4	8	16	32	64	128

### Analog Function Control 2

CV #	F0	F9	F10	F11	F12	F13	F14	F15
14	1	2	4	8	16	32	64	128

## 12.8. LGB@-Pulse Sequence Mode

It is possible to switch to pulse sequence mode for operations with the LGB@ command station and the Roco@ Lokmaus I. To do so, set bit 5 in CV 49. From now on decoder counts the number of times the F1 button is pressed in order to activate the desired function. Thus, it is possible to reach all function buttons by repeated pushing of the F1 button.

## 12.9. Swiss Headlight Mode

Function mapping enables you to set many different configurations. The Swiss headlight mode is a good example. We need a third lighting circuit that switches the left lower headlight of the „A“- headlight configuration whenever the lights are turned on. This third circuit must work independently from the direction of travel.

Figure 27 shows one option of how to wire this arrangement with AUX1 (green wire) being used for the third circuit. All you have to do now is to program the decoder in such a way that it always switches on that third circuit when the lighting function is active. In order to do so enter value 5 in CV 330 and value 6 in CV 346. (Don't forget to firstly set the index register CV 31 to value 16 and CV 32 to value 2!). That's it.

# Rear functions

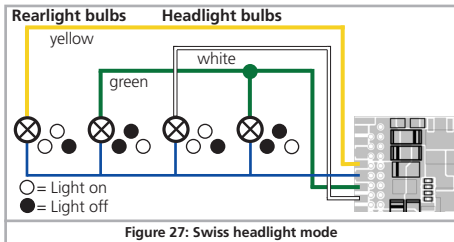

## 12.10. Virtual Drive Sound Start-up Delay

LokPilot decoders are very often used in traction with locomotives with LokSound decoders. If a locomotive with LokSound starts moving from a standstill (by turning up the regulator, so to speak), the locomotive will not start moving immediately. Rather, the diesel engine will first pick up speed or a steam locomotive will release the brakes and slowly fill the cylinders. It therefore takes a certain time before the locomotive starts moving. The LokPilot must also simulate this delay so that both locomotives start moving at the same time. But only when the sound is switched on. You can set the start-up delay of the LokPilot 5 decoder in CV 252 in steps of 65ms. The required value depends on the noise

project that is built into the LokSound and must be determined experimentally. The start-up delay is only active if the virtual driving noise is active in function mapping.

## 13. Random functions

LokPilot 5 can trigger up to 8 functions randomly. Logical functions or physical outputs can be enabled. Each random function is triggered like a (randomly controlled) button on the controller. For this to work, a function key must be defined in Function Mapping for each randomly triggered function. This is usually always the case anyway. For each random function, the following parameters can be set separately:

- Which function key (F0 to F31) should be triggered.
- Whether the random function should be triggered when stationary, driving or both.
- Whether the random function should only be triggered when the driving sound (main prime mover sound) is switched on.
- The minimum and maximum on-time of the random function. The actual on-time calculates the decoder randomly between these two values.
- The minimum and maximum pause time for this random function. In practice, this value defines the time „gap“ before the random function in question is triggered again.

The following table shows which values must be written into which CVs to correctly configure the random functions:

Random Function	CV 32	Range					Virtual Prime Mover On only	On-Time Min.	On-Time Max.	Pause Time Min.	Pause Time Max.
		Configuration	Function Key	Stopped	Driving						
Random Function 1	13	CV 257	0-31	+64	+128	+32	CV 258	CV 259	CV 260	CV 261	
Random Function 2	13	CV 265	0-31	+64	+128	+32	CV 266	CV 267	CV 268	CV 269	
Random Function 3	13	CV 273	0-31	+64	+128	+32	CV 274	CV 275	CV 276	CV 277	
Random Function 4	13	CV 281	0-31	+64	+128	+32	CV 282	CV 283	CV 284	CV 285	
Random Function 5	13	CV 289	0-31	+64	+128	+32	CV 290	CV 291	CV 292	CV 293	
Random Function 6	13	CV 297	0-31	+64	+128	+32	CV 298	CV 299	CV 300	CV 301	
Random Function 7	13	CV 305	0-31	+64	+128	+32	CV 306	CV 307	CV 308	CV 309	
Random Function 8	13	CV 313	0-31	+64	+128	+32	CV 314	CV 315	CV 316	CV 317	



# Decoder Reset

The switch-on times and the pause times can be specified from 0-255 seconds (unit: 1 second).

The value for the configuration CV is as follows: Add the value 32, 64 and 128 to the desired function key as numerical value (light key counts as „0“), depending on when the random function should be triggered.

Example: The random function 3 should trigger F13, and only if the Virtual Prime Mover is active and the locomotive is stationary. Therefore write the value in CV 272 ( $13 + 32 + 64 = 109$ ).



Please set index registers CV 31 to 16 and CV 32 to 13 before you change values.

Note the following:

- Each random function is independent of the other random functions. Thus, at a time, several random functions can be active at the same time.
- If the minimum and maximum pause times are set to the same value, then the tripping will be at a steady rate.
- If the minimum and maximum on-time are set equal, the random function will always be triggered the same amount of time.

## 14. Decoder-Reset

You can reset the decoder to the default settings at any time.

### 14.1. With DCC-Systems or 6020/6021

Enter the value 08 in CV 08.

### 14.2. With Märklin® systems (not for DCC only Decoders)

Mfx® decoders can be reset to factory default values with the Central Station® or the Mobile Station® via the reset command in the locomotive menu.

### 14.3. With the ESU LokProgrammer

In the menu „Programmer“, select option „Reset decoder“ and follow the instructions on the screen.

## 15. Special Functions

You may not yet be aware of some other highly specialised functions offered by LokPilot decoders.

### 15.1. Directional Bit

The directional bit determines the driving behaviour when transitioning from an analogue into a digital sector (also refer to chapter 10.3.). If you want to set this directional bit, then bit 0 in CV 124 must be set.0.

## 16. RailCom®

RailCom® was developed by Lenz® Elektronik, Giessen, Germany, and is a technology for transmitting information from the decoder back to the command station.

The locomotive can send the following information to the command station:

Locomotive address: The decoder transmits its address on request by „Broadcast“. Detectors in a certain track sector can detect this command. Thus, the command station can find out the location of that particular locomotive.

CV information: The decoder can provide feedback about all CV values to the command station per RailCom®. In future, a programming track will not be necessary any more.

Meta data: The decoder can transmit status information such as motor load, current draw of the motor, temperature etc. to the command station.

In order for RailCom® to work all decoders and the command station must be equipped accordingly. LokPilot decoders are RailCom®-ready in terms of their hardware. However, it may be necessary to carry out a firmware update in order to activate it.

# Firmware Update

Prior to use RailCom® must be unlocked by setting bit 3 in CV 29. CV 28 offers further options. Ex works, RailCom® is active in ESU LokPilot 5 decoders.

## 16.1. RailComPlus®

Decoders equipped with RailComPlus® will be automatically recognised by a RailComPlus®-compatible command station. You will never ever have to change the locomotive address of a new locomotive by hand! Just put the locomotive on the tracks and it will be recognised automatically. Also the name of the locomotive, the functional key symbols as well as the kind of the functions (long-term function and moment function) will be transferred. And all that happens within less seconds, you don't have to wait anymore!

### 16.1.1. Prerequisites for RailCom® Plus

RailComPlus® implies an accordingly equipped digital command station. The ESU ECoS command station supports RailComPlus®-capable decoders from software 3.4. You don't need to change anything about the decoder settings. It will be automatically recognised. Of course you can change the locomotive name, all functional key and locomotive symbols and after that write it back on your decoder. This happens automatically in the background. If you do not wish to have the automatic recognition, you can switch it off by deleting CV 28, bit 7.

## 17. Firmware Update

You can update LokPilot decoders with new operating software (so-called firmware) at any time. This is useful for fixing bugs and implementing new functions.

You can carry out the update yourself for free without having to remove the decoder from the locomotive. All you need is the ESU LokProgrammer. The software of the LokProgrammer will keep your LokPilot decoder up-to-date. A separate download is therefore not necessary.

Updates which are carried out by our service department will not be treated as a case of warranty. This service will be charged.

## 18. Accessories

You will get detailed information regarding accessories at your dealer or on our homepage.

### 18.1. Switching the Centre pick-up

The circuit board 51966 for switching the centre pick-up only for the decoder with the 21MTC interface is intended for vehicles with two pick-ups. Thus, you can activate the forward pick-up in the direction of movement. This is ideal for block control!

### 18.2. HAMO Magnets

One cannot drive the universal motors in many Märklin® models directly with a LokPilot decoder. Firstly, you must replace the stator coil with a permanent magnet. ESU supplies the following magnets:

51960	Permanent magnet as 220560, for Anker 217450, D=24,5mm, für motor plate 216730, 211990, 228500
51961	Permanent magnet as 220450, for Anker 200680, D=18,0mm, for motor plate 204900
51962	Permanent magnet as 235690, for Anker 231440, D=19,1mm, for motor plate 231350
51965	Permanent magnet, for Märklin 3015, ET800, ST800, Gauge 1 all-current motors

### 18.3. Wire Harnesses with 8-pole or 6-pole Socket

If the locomotive you want to convert does not have an interface and you do not want to remove the plug from the decoder then you can use the harness 51950 or 51951: First install the suitable harness and then plug in the decoder.

### 18.4. Mounting Adapter boards

If you wish to convert a locomotive with a LokPilot decoder with the 21MTC interface, the adapter plate 51967 comes in handy: it has a socket for plugging in the LokPilot but also has solder points for connecting the original wiring of the locomotive. This is ideal for converting Märklin® locomotives.

# Support and Assistance

With article no. 51968 or 51957 we offer an adapter board which amplifies the outputs AUX3 to AUX10 through a transistor and are therefore accessible. Ideal for complex conversions!

Under the number 51958 an adapter board for PluX22 is available.

## 19. Support and Assistance

Your model train dealer or hobby shop is your competent partner for all questions regarding your LokPilot decoder. In fact he is your competent partner for all questions around model trains.

There are many ways to get in touch with us. For enquiries please use either email, fax (please provide your fax-no. or email address) or go to [www.esu.eu/en/forum](http://www.esu.eu/en/forum) and we will reply within a few days.

Please call our hotline only in case of complex enquiries that can't be dealt with by email or fax. The hotline is often very busy and you may encounter delays. Rather send an email or fax and also check our website for more information. You will find many hints under "Support / FAQ" and even feedback from other users that may help you with your particular question.

Of course we will always assist you; please contact us at:

### **USA & Canada (English support), please contact:**

Phone: +1 570-980-1982  
Tuesday & Thursday 8:00am - 4:00pm (EST)  
Email: [support@loksound.com](mailto:support@loksound.com)  
Mail: ESU LLC  
1304 Jordan Ave  
Montoursville Pennsylvania 17754  
USA

### **Germany and all other countries, please contact:**

Email: [www.esu.eu/en/forum](http://www.esu.eu/en/forum)  
Mail: ESU GmbH & Co. KG  
- Technical support -  
Edisonallee 29  
D-89231 Neu-Ulm  
[www.esu.eu](http://www.esu.eu)

## 20. CV table LokPilot Decoder

 On the following pages, we have listed all CVs of LokPilot decoders in a chart.

Please only change CVs if you are certain about their purpose and the impact of your action. Wrong CV settings can lead to impaired performance or may cause your LokPilot not to respond at all.

CV	Name	Description	Range	Value
1	Loco address	Address of engine (For Multiprotocol decoders: Range 1-255 for Motorola)	1 - 127	3
2	Start voltage	Sets the minimum speed of the engine	1 - 255	3
3	Acceleration	This value multiplied by 0.25 is the time from stop to maximum speed. For LokSound 5 DCC: The unit is 0.896 seconds.	0 - 255	28
4	Deceleration	This value multiplied by 0.25 is the time from maximum speed to stopFor LokSound 5 DCC: The unit is 0.896 seconds.	0 - 255	21
5	Maximum speed	Maximum speed of the engine	0 - 255	255
6	Medium speed	Medium speed of the engine. Use only if 3-point speed table is enabled. For LokSound 5 DCC only.		
7	Version number	Internal software version of decoder	-	-
8	Manufacturer's ID	Manufacturers's ID ESU - Writing value 8 in this CV triggers a reset to factory default values.	151	-
9	Motor PWM Frequency	Motor PWM frequency as a multiple of 1000 Hz.	10 - 50	40
13	Analog Mode F1-F8	Status of functions F1 to F8 in analogue mode (see chapter 12.7).	0-255	1
14	Analog Mode FL, F9-F15	Status of function F0, F9 to F12 in analogue mode (see chapter 12.7).	0-63	1
15 16	Decoder lock	Decoder-Lock Function according to NMRA. For details please see: <a href="http://www.nmra.org/standards/DCC/WGpublic/0305051/0305051.html">http://www.nmra.org/standards/DCC/WGpublic/0305051/0305051.html</a>	0 - 255	0
17 18	Long address of the loco	Long address of engine (see chapter 9.2).	128 - 9999	192
19	Consist Address	Additional address for consist operation. Value 0 or 128 means: consist address is disabled 1 – 127 consist address active, normal direction 129 – 255 consist address active reverse direction	0-255	0
21	Consist Mode F1-F8	Status of functions F1 to F8 in Consist mode Meaning of the bits as in CV 13.	0-255	0
22	Consist Mode FL, F9-F12	Status of functions FL, F9 to F12 in Consist mode Meaning of the bits as in CV 14.	0-63	0

## CV table

CV	Name	Description	Range	Value																											
23	Adjust Acceleration	Factor for adjusting Acceleration CV 3. Values from 0 to 127 are added to CV 3. If the values are to be subtracted, additionally set bit 7 (value 128). The unit is 0.896 seconds.	0 - 127	0																											
24	Adjust Deceleration	Factor for adjusting the deceleration CV 4. Values from 0 to 127 are added to CV 3. If the values are to be subtracted, additionally set bit 7 (value 128). The unit is 0.896 seconds.	0 - 127	0																											
27	Brake mode	Allowed (enabled) Brake modes		28																											
		<table border="1"> <thead> <tr> <th>Bit</th> <th>Function</th> <th>Value</th> </tr> </thead> <tbody> <tr> <td>0</td> <td>ABC braking, voltage higher on the right hand side</td> <td>1</td> </tr> <tr> <td>1</td> <td>ABC braking, voltage higher on the left hand side</td> <td>2</td> </tr> <tr> <td>2</td> <td>ZIMO® HLU brakes active</td> <td>4</td> </tr> <tr> <td>3</td> <td>Brake on DC, if polarity against driving direction</td> <td>8</td> </tr> <tr> <td>4</td> <td>Brake on DC, if polarity like driving direction</td> <td>16</td> </tr> <tr> <td>5</td> <td>Selectrix brake diode, brakes if polarity is against driving direction</td> <td>32</td> </tr> <tr> <td>6</td> <td>Selectrix brake diode, rakes if polarity is like driving direction</td> <td>64</td> </tr> <tr> <td>7</td> <td>Loco brakes with constant brake distance if Speed=0</td> <td>128</td> </tr> </tbody> </table>	Bit	Function	Value	0	ABC braking, voltage higher on the right hand side	1	1	ABC braking, voltage higher on the left hand side	2	2	ZIMO® HLU brakes active	4	3	Brake on DC, if polarity against driving direction	8	4	Brake on DC, if polarity like driving direction	16	5	Selectrix brake diode, brakes if polarity is against driving direction	32	6	Selectrix brake diode, rakes if polarity is like driving direction	64	7	Loco brakes with constant brake distance if Speed=0	128		
Bit	Function	Value																													
0	ABC braking, voltage higher on the right hand side	1																													
1	ABC braking, voltage higher on the left hand side	2																													
2	ZIMO® HLU brakes active	4																													
3	Brake on DC, if polarity against driving direction	8																													
4	Brake on DC, if polarity like driving direction	16																													
5	Selectrix brake diode, brakes if polarity is against driving direction	32																													
6	Selectrix brake diode, rakes if polarity is like driving direction	64																													
7	Loco brakes with constant brake distance if Speed=0	128																													
28	RailCom® Configuration	Settings for RailCom®		131																											
		<table border="1"> <thead> <tr> <th>Bit</th> <th>Function</th> <th>Value</th> </tr> </thead> <tbody> <tr> <td>0</td> <td>Channel 1 Address broadcast enabled</td> <td>1</td> </tr> <tr> <td>1</td> <td>Data transmission allowed on Channel</td> <td>2</td> </tr> <tr> <td>7</td> <td>RailCom® Plus automatic loco recognition active</td> <td>128</td> </tr> </tbody> </table>	Bit	Function	Value	0	Channel 1 Address broadcast enabled	1	1	Data transmission allowed on Channel	2	7	RailCom® Plus automatic loco recognition active	128																	
Bit	Function	Value																													
0	Channel 1 Address broadcast enabled	1																													
1	Data transmission allowed on Channel	2																													
7	RailCom® Plus automatic loco recognition active	128																													

# CV table

CV	Name	Description	Range	Value		
29	Configuration register	This register contains important information, some of which are only relevant for DCC operation.		12		
		<b>Bit</b>			<b>Function</b>	<b>Value</b>
		0			Normal direction of travel Reversed direction of travel	0 1
		1			14 speed steps DCC 28 or 128 speed steps DCC	0 2
		2			Disable analog operation Enable analog operation	0 4
		3			Disable RailCom® Enable RailCom®	0 8
		4			Speed curve through CV 2, 5, 6 (LokSound 5 DCC ONLY). Speed curve through CV 67 - 94 (Multiprotocol)	16
		5			Short addresses (CV 1) in DCC mode Long addresses (CV 17 + 18) in DCC mode	0 32
31	Index Register H	Selection page for CV257-512. For LokPilot 5 usually set to 16	16	16		
32	Index Register L	Selection page for CV257-512	0 - 16	0		
47	Protocol selection	Which protocols are active. Please see chapter 9.5.	0 - 255	15		
		<b>Bit</b>			<b>Function</b>	<b>Value</b>
		0			DCC protocol active	1
		1			M4 protocol active (Not for LokPilot 5 DCC)	2
		2			Motorola® protocol active (Not for LokPilot 5 DCC)	4
3	Selectrix® protocol active (Not for LokPilot 5 DCC)	8				

# CV table

CV	Name	Description	Range	Value	
49	Extended Configuration #1	0	Disable Load control (Back-EMF) Enable Load control (Back-EMF)	1 0	0 - 255 19
		1	Reserved	2	
		2	Reserved	4	
		3	Märklin® Consecutive addresses, „low“-Bit	0, 8	
		4	Automatic DCC speed step detection Disable DCC speed step detection Enable DCC speed step detection	0 16	
		5	LGB® function button mode Disable LGB® function button mode Enable LGB® function button mode	0 32	
		6	Reserved	64	
		7	Märklin® Consecutive addresses, „High“-Bit Please consider chapter 9.3.1. for explanation of Bit 3, 7	0, 128	
50	Analogue mode	Selection of allowed analogue modes		0 - 3 3	
		Bit	Function		Value
		0	AC Analogue Mode Disable AC Analog Mode Enable AC Analog Mode		0 1
		1	DC Analogue mode Disable DC Analogue mode Enable DC Analogue Mode		0 2
		2	QSI Quantum Engineer DC Support Disable QSI Quantum Engineer Support Enable QSI Quantum Engineer Support		0 4
51	«K Slow» Cutoff	Internal Speedstep, until «K Slow» is active	0 - 255	10	
52	BEMF Param. «K Slow»	«K» -Portion of the PI-Controller valid for lower speed steps	0 - 255	10	
53	Control Reference voltage	Defines the Back EMF voltage, which the motor should generate at maximum speed. The higher the efficiency of the motor, the higher this value may be set. If the engine does not reach maximum speed, reduce this parameter.	0 - 255	130	

# CV table

CV	Name	Description	Range	Value
54	Load control Parameter «K»	«K»—component of the internal PI-controller. Defines the effect of load control. The higher the value, the stronger the effect of Back EMF control.	0 - 255	50
55	Load control Parameter «I»	«I»—component of the internal PI-controller. Defines the momentum (inertia) of the motor. The higher the momentum of the motor (large flywheel or bigger motor), the lower this value has to be set.	0 - 255	100
56	BEMF Influence at VMin	0 – 100 % Defines the "Strength" of the BEMF at minimum speed step.	1 - 255	255
57	Reserved	-	-	-
58	Reserved	-	-	-
63	Reserved	-	-	-
64	Reserved	-	-	-
65	Reserved	-	-	-
66	Forward Trimm	Divided by 128 is the factor used to multiply the motor voltage when driving forward. The value 0 deactivates the trim.	0 - 255	128
67-94	Speed table	Defines motor voltage for speed steps. The values „in between" will be interpolated.	0 - 255	-
95	Reverse Trimm	Divided by 128 is the factor used to multiply the motor voltage when driving backwards. Value 0 deactivates the trim.	0 - 255	128
101	Shunting Mode Trimm	Divided by 128, this gives the factor by which the motor voltage is multiplied when the shunting gear is active. See section 10.1.2.	0 - 128	64
102	Brake Mode Exit Delay	Time as a multiple of 16 milliseconds that must pass before a detected braking distance is left again. See section 10.4.6.	0 - 255	12
103	Load adjustment „Optional Load"	Divided by 128, this gives the factor that changes CV3, CV4 and the sound when „Optional Load" is active. See section 10.7.	0 - 255	0
104	Load adjustment „Primary Load"	Divided by 128, this gives the factor that changes CV3, CV4 and the sound when „Primry Load" is active. See section 10.7.	0 - 255	255
105	User CV #1	Free CV. Here you are able to save what ever you want.	0 - 255	0
106	User CV #2	Free CV. Here you are able to save what ever you want.	0 - 255	0
111	Gearbox backlash	Time as a multiple of 16 mS, for which the motor runs at minimum speed after reversing the direction to prevent gear box jerking.	0 - 255	0



# CV table

CV	Name	Description	Range	Value																											
112	Frequency for Flashing light effects	Flashing frequency for Strobe lighting effects. Multiple of 0.065536 seconds. See section 12.5.4.	0 - 255	20																											
113	Power Fail Bypass	The time that the decoder bridges via the PowerPack after an interruption of voltage. Unit: A multiple of 0.032768 sec. See section 6.12.2.	0 - 255	32																											
116	Slow speed BEMF Sampling period	Frequency of BEMF measurement in 0.1 milliseconds at speed step 1	25 - 200	50																											
117	Full speed BEMF Sampling period	Frequency of BEMF measurement in 0.1 milliseconds at speed step 255	25 - 200	150																											
118	Slow speed BEMF Measurement gap length VMin	Length of the BEMF measuring gap in 0.1 milliseconds at speed step 1	3 - 40	15																											
119	Full speed BEMF Measurement gap length Vmax	Length of the BEMF measuring gap in 0.1 milliseconds at speed step 255	3 - 40	20																											
123	ABC Mode „Slow drive“	Speed which is valid in the slow driving section during ABC braking	0 - 255	100																											
124	Extended Configuration #2	Additional important settings for decoders	-	28																											
		<table border="1"> <thead> <tr> <th>Bit</th> <th>Description</th> <th>Value</th> </tr> </thead> <tbody> <tr> <td>0</td> <td>Bi-directional bit: Keep driving direction when changing direction. Do not keep driving direction.</td> <td>1 0</td> </tr> <tr> <td>1</td> <td>Disable SUSI slave protocol Enable SUSI slave protocol</td> <td>0 2</td> </tr> <tr> <td>2</td> <td>Disable prime mover startup delay Enable prime mover startup delay</td> <td>0 4</td> </tr> <tr> <td>3</td> <td>Disable SUSI serial protocol Enable SUSI serial protocol</td> <td>0 8</td> </tr> <tr> <td>4</td> <td>Enable Output AUX10 (LokSound 5 H0 only) Enable Wheel Sensor input (LokSound 5 H0 only)</td> <td>0 16</td> </tr> <tr> <td>5</td> <td>Motor Overload Protection Motor is not switched off when blocked. Motor is switched off for a few seconds when blocked to avoid burnout</td> <td>0 32</td> </tr> <tr> <td>6</td> <td>Disable Automatic parking Brake Enable Automatic parking Brake (EMK Braking)</td> <td>0 64</td> </tr> <tr> <td>7</td> <td>AUX3, AUX4 Logic Level at 21MTC (only LokPilot 5 Fx) AUX3, AUX4 Power at 21MTC (only LokPilot 5 Fx)</td> <td>0 128</td> </tr> </tbody> </table>	Bit	Description	Value	0	Bi-directional bit: Keep driving direction when changing direction. Do not keep driving direction.	1 0	1	Disable SUSI slave protocol Enable SUSI slave protocol	0 2	2	Disable prime mover startup delay Enable prime mover startup delay	0 4	3	Disable SUSI serial protocol Enable SUSI serial protocol	0 8	4	Enable Output AUX10 (LokSound 5 H0 only) Enable Wheel Sensor input (LokSound 5 H0 only)	0 16	5	Motor Overload Protection Motor is not switched off when blocked. Motor is switched off for a few seconds when blocked to avoid burnout	0 32	6	Disable Automatic parking Brake Enable Automatic parking Brake (EMK Braking)	0 64	7	AUX3, AUX4 Logic Level at 21MTC (only LokPilot 5 Fx) AUX3, AUX4 Power at 21MTC (only LokPilot 5 Fx)	0 128		
Bit	Description	Value																													
0	Bi-directional bit: Keep driving direction when changing direction. Do not keep driving direction.	1 0																													
1	Disable SUSI slave protocol Enable SUSI slave protocol	0 2																													
2	Disable prime mover startup delay Enable prime mover startup delay	0 4																													
3	Disable SUSI serial protocol Enable SUSI serial protocol	0 8																													
4	Enable Output AUX10 (LokSound 5 H0 only) Enable Wheel Sensor input (LokSound 5 H0 only)	0 16																													
5	Motor Overload Protection Motor is not switched off when blocked. Motor is switched off for a few seconds when blocked to avoid burnout	0 32																													
6	Disable Automatic parking Brake Enable Automatic parking Brake (EMK Braking)	0 64																													
7	AUX3, AUX4 Logic Level at 21MTC (only LokPilot 5 Fx) AUX3, AUX4 Power at 21MTC (only LokPilot 5 Fx)	0 128																													

# CV table

CV	Name	Description	Range	Value
125	Start voltage Analog DC	See section 10.8.	0 - 255	90
126	Maximum speed Analog DC	See section 10.8.	0 - 255	130
127	Start voltage Analog AC	See section 10.8.	0 - 255	90
128	Maximum speed Analog AC	See section 10.8.	0 - 255	130
129	Analog Functions „Hysteresis“	Offset voltage for functions in analogue mode. Chapter 10.8.	0 - 255	15
130	Analog Motor „Hysteresis“	Offset voltage for motor functions in analogue mode. Chapter 10.8.	0 - 255	5
132	Grade Crossing Hold Time	Grade Crossing holding time. See chapter 12.5.3.	0 - 255	80
133	Reserved	-	-	-
134	ABC-Mode „Sensibility“	Threshold, from which asymmetry on ABC shall be recognised.	4 - 32	10
138	Reserved	-	-	-
139	Reserved	-	-	-
140	Reserved	-	-	-
141	Reserved	-	-	-
142	Reserved	-	-	-
143	Reserved	-	-	-
144	Reserved	-	-	-
149	ABC Shuttle Train Holdtime	Time in seconds, which has to be passed for ABC shuttle train operation, before the direction of travel is changed. See section 10.4.4.3.	0 - 255	255
150	HLU Speedlimit 1	HLU Speed limit 1. Internal speedstep.	0 - 255	42
151	HLU Speedlimit 2 (U)	HLU Speed limit 2 (U). Internal speedstep.	0 - 255	85
152	HLU Speedlimit 3	HLU Speed limit 3. Internal speedstep.	0 - 255	127
153	HLU Speedlimit 4 (L)	HLU Speed limit 4 (L). Internal speedstep.	0 - 255	170
154	HLU Speedlimit 5	HLU Speed limit 5. Internal speedstep.	0 - 255	212

## CV table

CV	Name	Description	Range	Value
179	Brake Function 1 Deceleration	Value of which 33% of CV 4 will be deducted if the Brake Function 1 is active. See section 10.6.	0 - 255	80
180	Brake Function 2 Deceleration	Value of which 33% of CV 4 will be deducted if the Brake Function 2 is active. See section 10.6.	0 - 255	40
181	Brake Function 3 Deceleration	Value of which 33% of CV 4 will be deducted if the Brake Function 3 is active. See section 10.6.	0 - 255	40
182	Brake Function 1 max. Speed	Highest speed step that can be reached when Brake function 1 is active.	0 - 126	0
183	Brake Function 2 max. Speed	Highest speed step that can be reached when Brake function 2 is active.	0 - 126	126
184	Brake Function 3 max. Speed	Highest speed step that can be reached when Brake function 3 is active.	0 - 126	126
246	Automatic decoupling Driving speed	Speed of the loco while decoupling; the higher the value, the faster the loco. Value 0 switches the automatic coupler off. Automatic decoupling is only active if the function output is adjusted to „pulse“ or „coupler“.	0 - 255	0
247	Decoupling - Removing time	This value multiplied with 0.016 defines the time the loco needs for moving away from the train (automatic decoupling).	0 - 255	0
248	Decoupling - Pushing time	This value multiplied with 0.016 defines the time the loco needs for pushing against the train (automatic decoupling).	0 - 255	0
249	Minimum steam chuff distance	Minimum distance of two steam chuffs, independant from sensor data. Compage chapter 13.3.	0 - 255	0
250	Reserved	-	-	-
253	Constant brake mode	Determines the constant brake mode. Only active, if CV254 > 0 Function CV 253 = 0: Decoder stops linearly CV 253 > 0: Decoder stops constantly linear	0 - 255	0
254	Constant braking distance forward	A value > 0 determines the way of brake distance it adheres to, independent from speed.	0 - 255	0
255	Constant braking distance backward	Constant braking distances during reverse driving. Only active, if value > 0, otherwise the value of CV 254 is used. Useful for reversible trains.	0 - 255	0

## 21. Appendix

### 21.1. Programming Long Addresses

As described in chapter 9.2, the long address is split into two CVs. The byte with the higher value of the address is in CV 17. This byte determines the range in which the extended address will be located. For instance, if you enter the value 192 in CV 17 then the extended address may be between 0 and 255. If 193 is written into CV 17 then the extended address will be between 256 and 511. You can continue this up to addresses with values of 9984 and 10239. The possible values are shown in figure 35.

#### 21.1.1. Write address

To program a long address you first of all need to calculate the values for CV 17 and CV 18 and then program it. Please note that it is not possible to program addresses via the programming mode "POM".

To program the long address proceed as follows:

- First you determine the desired address, for instance 4007.
- Then you look for the appropriate address range in Fig. 35. The value to be entered into CV 17 can be found in the column on the right. In our example, it is 207.

The value for CV 18 is established as follows:

	desired address	4007
minus	first address in the address range -	3840
	=====	====
equals	value for CV 18	167

- 167 is therefore the value to be entered in CV 18. Thus you decoder is now programmed to address 4007.

#### 21.1.2. Read out address

If you wish to read out a loco address please read the values of CV 17 and CV 18 one after another and proceed then in reverse order:

Let's assume you have read:

CV 17 = 196; CV 18 = 147. Look up the corresponding address range in Fig. 23. The first possible address within this range is 1024. Then you have to add the value from CV 18 and you arrive at the locomotive address:

$$\begin{array}{r}
 1024 \\
 + 147 \\
 \hline
 = 1171
 \end{array}$$

Address range			Address range			Address range		
from	to	CV17	from	to	CV17	from	to	CV17
0	255	192	3584	3839	206	7168	7423	220
256	511	193	3840	4095	207	7424	7679	221
512	767	194	4096	4351	208	7680	7935	222
768	1023	195	4352	4607	209	7936	8191	223
1024	1279	196	4608	4863	210	8192	8447	224
1280	1535	197	4864	5119	211	8448	8703	225
1536	1791	198	5120	5375	212	8704	8959	226
1792	2047	199	5376	5631	213	8960	9215	227
2048	2303	200	5632	5887	214	9216	9471	228
2304	2559	201	5888	6143	215	9472	9727	229
2560	2815	202	6144	6399	216	9728	9983	230
2816	3071	203	6400	6655	217	9984	10239	231
3072	3327	204	6656	6911	218			
3328	3583	205	6912	7167	219			

# Warranty Certificate

## 24 months warranty form date of purchase

Dear customer,

Congratulations on purchasing this ESU product. This quality product was manufactured applying the most advanced production methods and processes and was subjected to stringent quality checks and tests.

Therefore ESU electronic solutions ulm GmbH & Co. KG grants you a warranty for the purchase of ESU products that far exceeds the national warranty as governed by legislation in your country and beyond the warranty from your authorised ESU dealer. ESU grants an extended

### **manufacturer's warranty of 24 months from date of purchase.**

#### Warranty conditions:

- This warranty is valid for all ESU products that have been purchased from an authorised dealer.
- No claims will be accepted without proof of purchase. The filled in warranty certificate together with your ESU dealer's receipt serves as proof of purchase. We recommend keeping the warranty certificate together with the receipt.
- In case of claim please fill in the enclosed fault description as detailed and precise as possible and return it with your faulty product.

#### Extend of warranty / exclusions:

This warranty covers free of charge repair or replacement of the faulty part, provided the failure is demonstrably due to faulty design, manufacturing, material or transport. Please use the appropriate postage stamps when shipping the decoder to ESU. Any further claims are excluded.

#### The warranty expires:

1. In case of wear and tear due to normal use
2. In case of conversions of ESU - products with parts not approved by the manufacturer
3. In case of modifications of parts, particularly missing shrink sleeves, or wires directly extended on the decoder
4. In case of inappropriate use (different to the intended use as specified by the manufacturer)
5. If the instructions as laid down in the user manual by ESU electronic solutions ulm GmbH & Co. KG were not adhere to

Due to liability reasons any inspections or repairs can only be carried out on products that are not installed in a locomotive or carriage. Any locomotive sent to ESU for inspection will be returned without even touching it. There is no extension of the warranty period due to any repairs or replacements carried out by ESU.

You may submit your warranty claims either at your retailer or by shipping the product in question with the warranty certificate, the receipt of purchase and fault description directly to ESU electronic solutions ulm GmbH & Co. KG:

ESU GmbH & Co. KG  
- Garantieabteilung -  
Edisonallee 29  
D-89231 Neu-Ulm

# Trouble shooting sheet

## 1. Personal data

(Please write in block letters)

Name: .....

Street: .....

ZIP/City: ..... | | | | |

Country: .....

Email: .....

Phone: .....

Date: .....

Signature: .....

## 2. Product details and system environment (use extra page if needed)











Art.No.: ..... Purchase Date: ..... Address: .....

Operation Mode:  AC Analogue  AC Digital  DC Analogue  DC Digital (DCC)

Digital system:  ESU ECoS  Märklin® 6012  ROCO® Digital  LGB® Digital  LGB® MZS

Intellibox®  Lenz® Digital  Others:

## 3. Error description

<input type="checkbox"/> Headlight output front 	<input type="checkbox"/> No Sound 	<input type="checkbox"/> Cable 
<input type="checkbox"/> Headlight output rear 	<input type="checkbox"/> Wrong Sound 	<input type="checkbox"/> Change direction probl 
<input type="checkbox"/> Motor output 	<input type="checkbox"/> Short circuit 	<input type="checkbox"/> Without any function (DOA)
<input type="checkbox"/> Programming 	<input type="checkbox"/> AUX output 	<input type="checkbox"/> Other problems: .....

## 4. Receipt

Please enclose your receipt / invoice. Otherwise no warranty possible!

## 5. Additional information:

.....

.....

.....

.....

.....

## 6. Your retailer:

.....

.....

.....

.....

.....

Retailer's stamp or address

